

ROY-BILT®

Owner/Operator Manual

PTO HORSE Tiller

- Safety
- Controls
- Operation
- Maintenance

Models

- 7 HP
- 8 HP

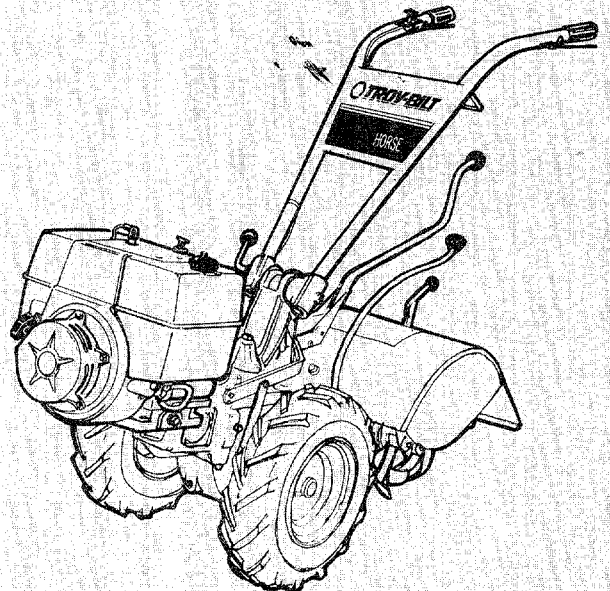

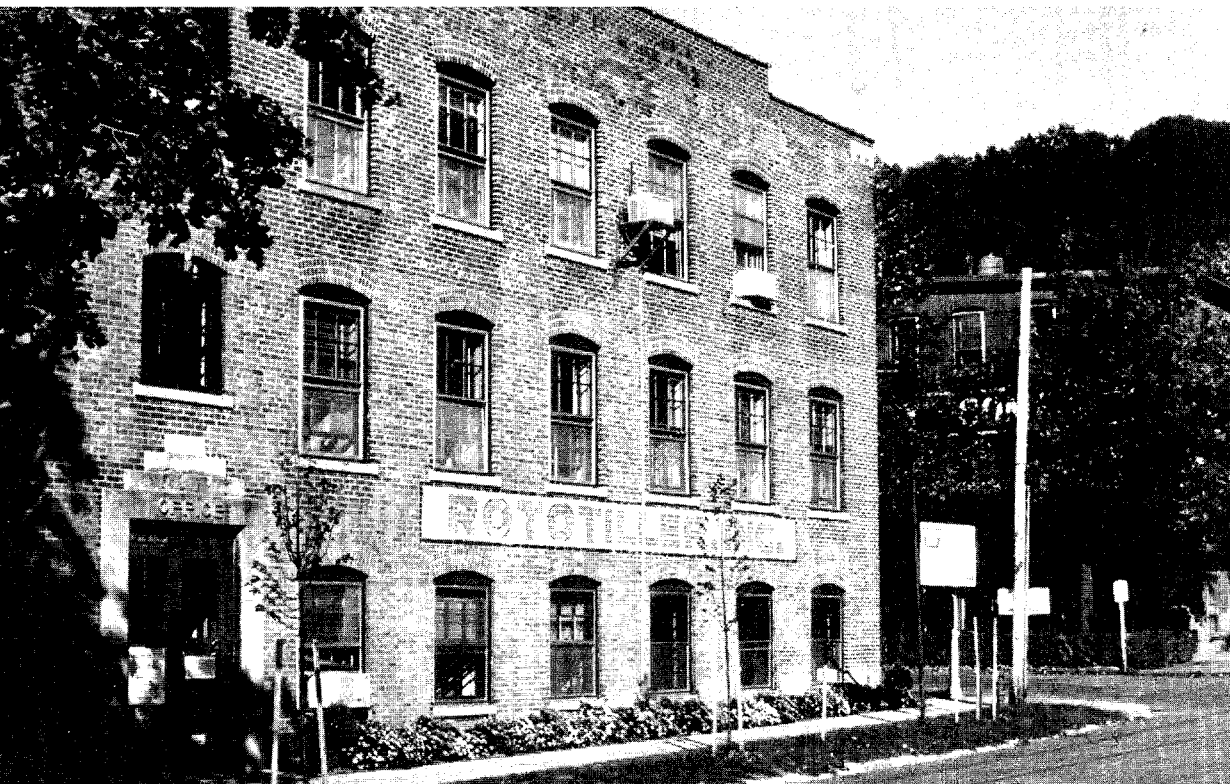

factory in Troy, N.Y., where tillers have been made since 1937. Please come and visit us.

We call your machine the PTO HORSE Model -BILT® Roto Tiller-Power Composter

hout this Owner/Operator Manual and in
r literature, we refer to your machine as the
RSE Model". The name aptly describes its
se ruggedness, and it distinguishes this
m the smaller ECONO-HORSE, PONY® and
models, as well as from other models that
n available in the past or that might be
l in the future.

story dates back to the old Rototiller Corpo-
e company that introduced rear-tine rotary

tillage to America in 1930. The first rear-tine tillers
Rototiller, Inc. built in Troy were manufactured in 1937,
in the same building where Garden Way built its first
HORSE Model in 1961. We're still building our tillers
at the same location.

Over the years, the PTO HORSE Model has been
continually refined and improved. Its performance
and reliability have long been recognized by many
thousands of serious vegetable gardeners as being
unmatched by any other tiller of its size or design.

WARNING TO ALL CALIFORNIA AND OTHER POWER EQUIPMENT OPERATORS

California law, and under the laws of several other states, you are not permitted to operate an
l combustion engine using hydrocarbon fuels on any forest covered, brush covered, or grass
d land, or on land covered with grain, hay, or other flammable agricultural crop, without an
spark arrester in continuous effective working order.

ngine on your power equipment, like most outdoor power equipment, is an internal combustion
that burns gasoline, a hydrocarbon fuel. Therefore, your power equipment must be equipped
spark arrester muffler in continuous effective working order. The spark arrester must be
ed to the engine exhaust system in such a manner that flames or heat from the system will not
flammable material. Failure of the owner / operator of the equipment to comply with this
ion is a misdemeanor under California law, and may also be a violation of other state and / or
regulations, laws, ordinances, or codes. Contact your local fire marshal or forest service for
c information about what regulations apply in your area.

Off to a Safe Start!

The PTO HORSE Model TROY-BILT® Tiller meets voluntary safety standard B71.8-1986, which is sponsored by the Outdoor Power Equipment Institute, Inc. and is published by the American National Standards Institute, Inc.

Your new tiller is basically a simple machine to operate. However, as with all new and unfamiliar powered equipment, you should thoroughly read and understand this Owner/Operator Manual and any other literature you received with your tiller before you attempt to start the engine. *Please carefully follow recommended operating instructions and safety practices closely at all times. Failure to do so could result in injury or property damage.*

ASSEMBLY INSTRUCTIONS NOTICE!

Included in your literature package is an Assembly Instructions Manual that provides step-by-step instructions on how to assemble your new tiller. If you purchased your tiller un-assembled, then be sure to read and follow the assembly instructions carefully.

Call our Technical Service Department immediately (see page 4) if the Assembly Instructions Manual is missing from your literature package, or if you have any questions about assembly. *Please don't attempt to assemble your tiller without proper instructions.*

CAUTION

TO AVOID INJURY:

- Read the Owner/Operator Manual.
- Know location and function of all controls.
- Keep all safety devices and shields in place.
- Never allow children or uninstructed adults to operate tiller.
- Shut off engine and disconnect spark plug wire before unclogging tines or making repairs.
- Keep bystanders away from machine.
- Keep away from rotating parts.

CONTENTS

Introduction 2

If You Need Service 4

Section 1: Safety Instructions 6

Section 2: Controls and Functions 9

Section 3: Operation of Tiller 16

Section 4: Tilling in the Garden 25

Section 5: The PTO Power Unit 32

Section 6: Maintenance and Service 36

Section 7: Troubleshooting 65

Section 8: Specifications 70

Section 9: Attachments and Accessories 72

Index 79

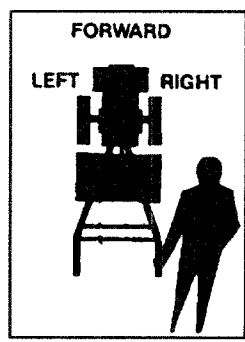

"OPERATOR'S POSITION"

All references to **LEFT** and **RIGHT** sides of the tiller are given from the operator's position behind the handlebars (unless specified otherwise).

Introduction

Welcome to "Power gardening the TROY-BILT® Tiller way." Your new PTO HORSE Model Tiller is a useful, productive gardening tool that, with proper care, should last for many years.

Your tiller was designed to easily chop up, shred and bury all sorts of vegetation and organic matter in the garden in addition to preparing seedbeds and cultivating. With optional tiller attachments it can also be used for furrowing and hilling, as well as light earthmoving and snow removal chores.

The PTO HORSE Model's design, with powered wheels ahead of the



separately geared Bolo Tines in the rear, gives it an outstanding combination of tilling and composting capabilities that allows you to enrich your soil far beyond your abilities to do so by hand. This soil enhancement is gained by tilling in

and burying organic materials such as leaves, mulches, crop residues, sod, green manure cover crops and even standing cornstalks! By using this method, you will soon experience better yields in your garden than ever before. This is said to be the greatest single benefit of power gardening "the different, better, and so much more enjoyable TROY-BILT® Tiller way."

We have tried our best to build your tiller as strong and trouble-free as we know how. This, of course, is to our mutual benefit. We have fewer service problems and you have a truly reliable machine.

VERY IMPORTANT!

Before trying to operate your tiller or PTO Power Unit for the first time, please make sure that you:

- 1** Complete all of the tiller assembly steps that are described in the separate Assembly Instructions Manual that came packaged with this Manual.
- 2** Read and understand all of the Safety Instructions in Section 1 of this Manual.
- 3** Completely familiarize yourself with all of the operating controls as described in Section 2 of this Manual.
- 4** Read and understand all of the operating procedures for the tiller and the PTO Power Unit, as described in Sections 3, 4 and 5 of this Manual.

REMEMBER . . . PRACTICE SAFETY AT ALL TIMES!

You also have a versatile PTO Power Unit . . .

In addition to being an incredibly efficient tiller, your machine can be quickly converted into a self-contained PTO (Power Take-Off) Power Unit that is capable of towing or powering various TROY-BILT PTO attachments (see Figure 2).

This ability to convert the tiller into a PTO Power Unit is made possible by the unique design of the Horse Model's transmission. As shown in Figure 3, the transmission is made up of two separate cast-iron housings that are held together by a locking collar, a dowel pin and two swing-bolts.

Each housing has separate drive shafts that are joined by a tine clutch. This clutch can be engaged or disengaged by moving the Tines/PTO Clutch Lever that is located on the left side of the PTO Power Unit transmission.

When the tine attachment is in place, the lever allows you to operate the tiller with the tines disengaged, even when the wheels are in motion. This tine disconnect feature provides added convenience when transporting, loading, or unloading the tiller. When the lever is in the engaged position,

the tine clutch connects the two drive shafts together, transmitting power to the tines.

If the tine attachment is removed (by loosening the two swing-bolts and sliding the attachment off), the PTO Power Unit can be used to tow moderate loads or drag-behind implements, or to provide engine power to powered stationary attachments such as the TROY-BILT® Generator, TROY-BILT® PTO Log Splitter and TROY-BILT® PTO Chipper/Shredder. This PTO capability truly makes your tiller an all-around, all-season work horse.

For detailed instructions on how to convert your tiller into a PTO Power Unit please refer to Section 5 in this Manual.

A word about maintenance . . .

You can help ensure long-lasting and proper performance from your PTO HORSE Model by always remembering to perform the scheduled maintenance services that are presented in Section 6 of this Manual, and in the accompanying engine manufacturer's Owner's Manual.

By treating your machine with good care in the manner described in those pages, your efforts will be returned many times over in the form of a more satisfying and easier operating machine, and with much more bountiful gardening results.

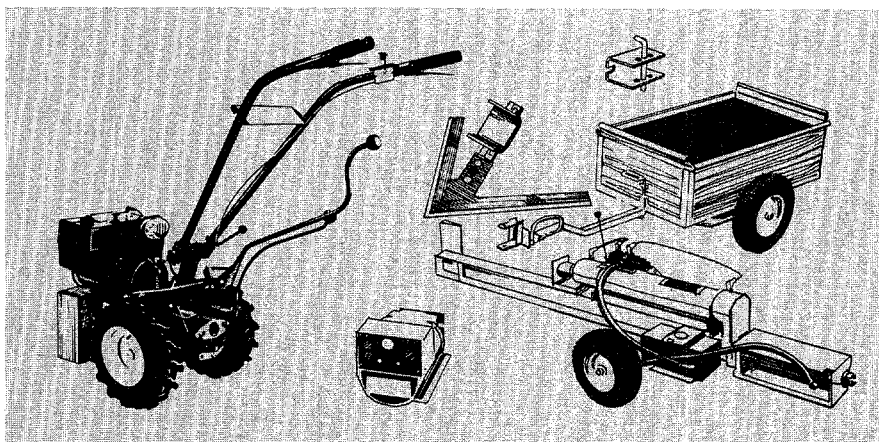

Figure 2: The tine attachment can be removed and various powered or non-powered attachments can be connected to the Power Unit.

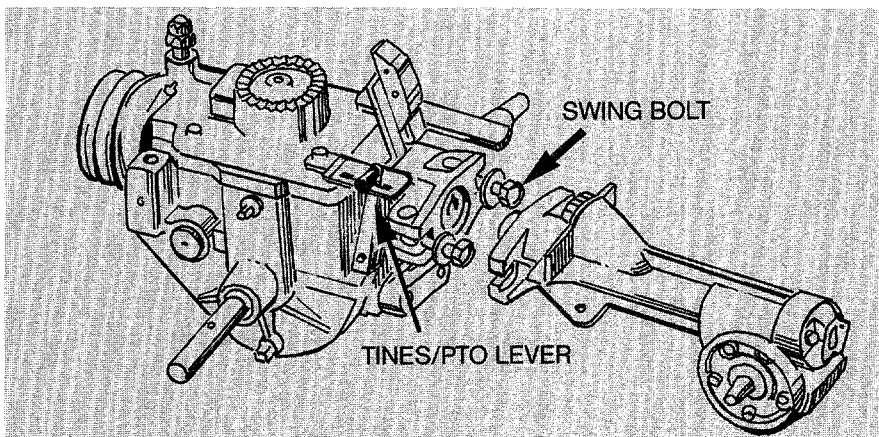
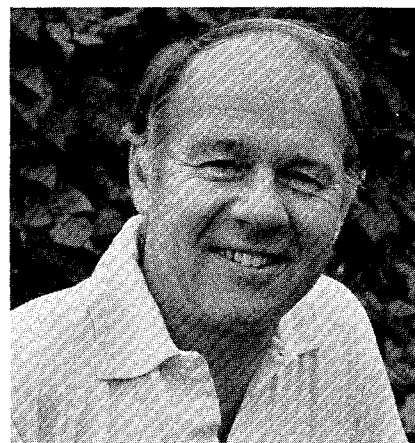

Figure 3: The transmission consists of two housings, held together by swing-bolts. Separate "dog" clutches on each drive shaft are engaged and disengaged with the Tines/PTO Clutch Lever.

We're here to serve you!

The whole idea behind TROY-BILT® Tiller Factory Service is to get parts, attachments and service advice out to you just as quickly as possible and to answer any questions you may have about tilling or gardening, by phone or by letter, depending upon what is needed.

Nothing is more important to all of us here at the factory than making sure that every owner is completely satisfied 100-percent of the time. You're always entitled to first-rate service. Please be assured that we will do our very best to see that you get it at all times.



Thank you,

Dean Leith, Jr.

Dean Leith, Jr., Sales Manager

If you have a question or problem . . .

If you have a question or problem that is not answered in this Manual, then please get in touch with our Technical Service Department by phone or by letter. One of our friendly, helpful tiller experts will gladly help you out.

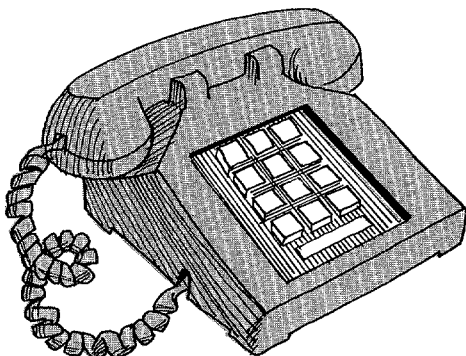

If you need a tiller part . . .

If you need to order a part for your tiller, please refer to the separate Parts Catalog that came with this Manual. There, you will find detailed instructions on how to identify parts and how to place your order.

If you need engine service or parts . . .

For engine service or parts, contact your nearest engine service dealer who is authorized to service the particular make of engine that is on your tiller. Look in the Yellow Pages of your telephone directory under "Engines—Gasoline" for the name of your nearest service dealer. The service dealer can handle all parts, repairs and warranty service concerning the engine alone.

It is important to remember that your engine is covered by the en-

gine manufacturer's Limited Warranty and any unauthorized work done on the engine during the warranty period may void your engine warranty. For full details on the engine's Limited Warranty, please see the separate engine manufacturer's Owner's Manual that came with this Manual.

If you have any difficulty in finding an authorized service dealer or in obtaining warranty service, please contact our Technical Service Department for assistance.

For the fastest service, DIAL FREE from:

In the U.S.A. (Toll-Free) 1-800-833-6990
In Canada (Garden Way Canada) (Toll-Free) 1-800-225-3585

Our business hours are (Eastern Time):

In the U.S.A.: M-F 8 a.m. to 7 p.m.; Sat. 9 a.m. to 4 p.m.
In Canada: M-F 8 a.m. to 5 p.m.

Our mailing address is:

In the U.S.A.

Troy-Bilt Mfg. Co.
102nd St. & 9th Ave.
Troy, New York 12180

In Canada

Garden Way Canada
1515 Matheson Blvd. E.
Mississauga, Ontario L4W 2P5

NOTE: When calling or writing, please provide us with your Tiller Serial Number (See page 5).

RECORD YOUR TILLER SERIAL NUMBER

To help you as quickly as possible when you write or call for service or parts, we will need to know your Tiller Serial Number.

The arrow in the Figure at the right points to a location on the transmission where the serial number is located. For ready reference, please record this number, along with the delivery date of your tiller, in the spaces provided below.

Serial Number: _____

Date of Delivery: _____

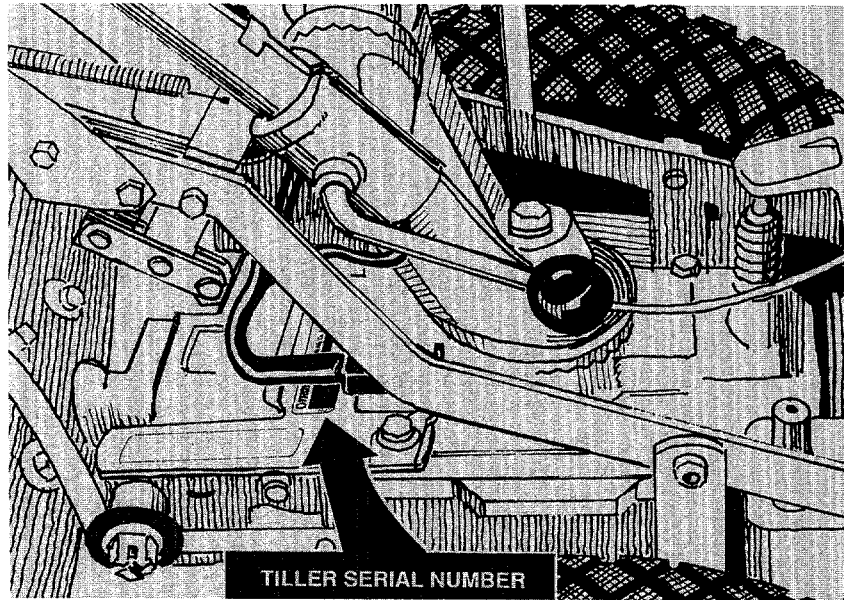

RECORD YOUR ENGINE MODEL NUMBER

Should you ever need engine service or parts, you may be asked for the engine model code number.

On the 7HP Briggs & Stratton engine, the number is stamped on the top of the blower housing cover, as shown in Photo 6.

On the 8HP Kohler engine, the number is located on the right side of the blower housing cover, behind the air cleaner cover (remove wing nut to remove air cleaner cover). See Photo 7.

Engine Code: _____



PHOTO 6: Code number location on 7HP Briggs & Stratton engine.

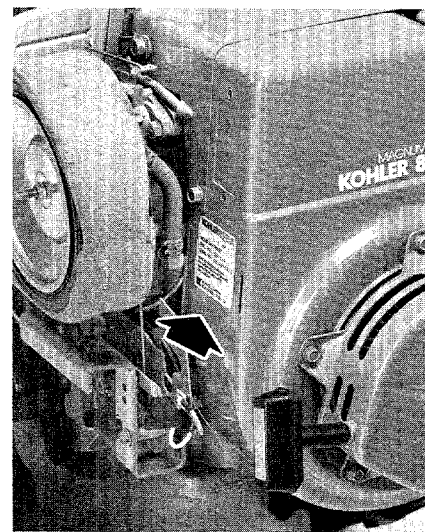

PHOTO 7: Code number location on 8HP Kohler engine.

SECTION 1: Safety Instructions

The PTO HORSE Model Tiller has been designed with many safety features to help protect individuals from harm and property from being damaged. However, as with any type of power equipment, it is necessary for you and any

operator to follow safe operating practices at all times. *Failure to do so can result in personal injury or damage to equipment or property.*

Before operating or servicing the tiller or the PTO Power Unit, carefully read and follow all of the

Safety Instructions found in this Owner/Operator Manual and in the separate Owner's Manual provided by the engine manufacturer. If you have any questions, please call or write us.

TRAINING

1. Read both this Owner/Operator Manual and the separate engine Owner's Manual carefully. Be thoroughly familiar with the controls and the proper use of the tiller and its engine. Know how to stop the unit and disengage the controls quickly.
2. Read the Owner/Operator Man-



SAFETY ALERT SYMBOL

This symbol is used to alert you to important safety messages in this Manual and on your tiller. When you see this symbol, carefully read and follow its safety message.

uals provided with any optional accessories or attachments before operating. The manuals provide a detailed description of proper use

- and operation, and point out other important Safety Instructions.
3. Never allow children to operate the tiller. Never allow adults to operate the tiller without proper instruction.
 4. Keep the area of operation clear of all persons (particularly small children), and pets.

PREPARATION

1. Thoroughly inspect the area where the tiller is to be used and remove all foreign objects before tilling.
2. Put the Wheels/Tines/PTO Drive Lever in "NEUTRAL" before starting the engine.
3. Do not operate the tiller without wearing suitable outer garments. Avoid loose garments or jewelry that could get caught in moving parts of the tiller or its engine.
4. Do not operate the tiller when barefoot or wearing sandals, sneakers, or similar lightweight

footwear. Wear footwear which will improve footing on slippery surfaces.

5. Do not till near underground electric cables, telephone lines, pipes, or hoses. If in doubt, contact your telephone or utility company to locate underground services.

6. Handle fuel with care; it is highly flammable and its vapors are explosive.

- (a) Use an approved fuel container.

- (b) Never remove gas cap or add fuel to a running engine or to a hot engine. Engine shall be allowed to cool before refueling.

- (c) Keep matches, cigarettes, cigars, pipes, open flames, or sparks away from the fuel tank and fuel container.

- (d) Fill fuel tank outdoors with extreme care. Never fill fuel tank indoors. Use a funnel or spout to prevent spilling.

- (e) Replace fuel cap securely and clean up spilled fuel before restarting.

7. Never attempt to make any adjustments while the engine is running or the spark plug wire is connected, except where specifically instructed to do so.

OPERATION

1. Do not put hands or feet near or under rotating parts.
2. Exercise extreme caution when operating on or crossing gravel drives, walks, or roads. Stay alert for hidden hazards or traffic.
3. After striking a foreign object, stop the engine, remove the key on electric start models, disconnect the spark plug wire, and thoroughly inspect the tiller for any damage. Repair the damage before restarting and operating the tiller.
4. Exercise caution to avoid slipping or falling.
5. If the machine should start to vibrate abnormally, stop the engine, remove the wire from the spark plug, and check immediately for the cause. Vibration is generally a warning of trouble.
6. Stop the engine, remove the key on electric start models, and disconnect the spark plug whenever you leave the operating position, before unclogging the tines, and when making any repairs, adjustments, or inspections.
7. Take all possible precautions when leaving the tiller unattended. Shift into "NEUTRAL", stop the engine, remove the key on electric start models, and disconnect the spark plug wire to prevent accidental starting.
8. Before cleaning, repairing, or inspecting, stop the engine, remove the key on electric start models, and make certain all moving parts have stopped. Disconnect the spark plug wire and keep the wire away from the plug to prevent accidental starting. For electrical safety, always remove the cable from the negative (-) side of the battery (on electric start models) before attempting any repairs or maintenance.
9. Always keep the flap on the tine hood down when operating the tiller, except when using the hiller/furrower attachment.

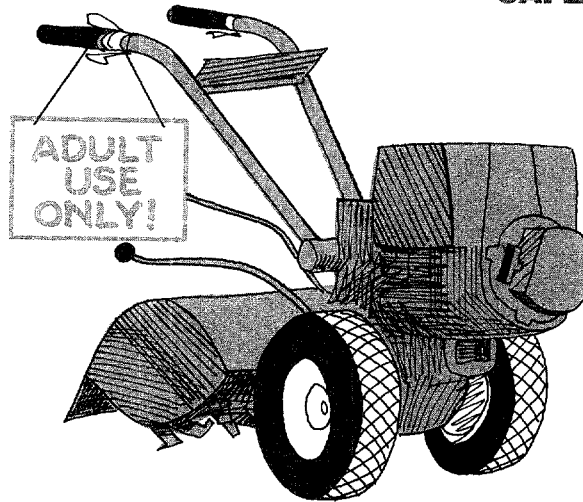

10. Never operate the tiller without proper guards, shields, plates, or other safety protective devices in place.
11. Do not run the engine in an enclosed area; exhaust fumes contain carbon monoxide gas, a deadly poison that is odorless, colorless and tasteless. Always make sure there is adequate ventilation when the engine is running.
12. Keep children and pets away.
13. Never operate the tiller under engine power if the Wheel Speed Lever is in the "FREE WHEEL" position. In "FREE WHEEL", the wheels will not hold the tiller back and the revolving tines could propel the tiller rapidly, possibly causing loss of control. Always engage the Wheel Speed Lever in either the "FAST" or "SLOW" wheel speed position before starting the engine or engaging the tines with the Wheels/Tines/PTO Drive Lever.
14. Be aware that the tiller may unexpectedly bounce upward or jump forward and be propelled away from you if the tines should strike or catch extremely hard-packed soil, sod, frozen ground, or buried obstacles such as large stones, roots, or stumps. If you are in doubt about the tilling conditions, always use the following operating precautions to assist you in maintaining control of the tiller.
 - (a) Walk behind and to one side of the tiller, using just one hand on the handlebars. Relax your arm, but use a secure hand grip.
 - (b) Use shallower depth regulator settings, gradually working down deeper with each tilling pass.
 - (c) Use slower wheel, tine and engine throttle speeds.
 - (d) Clear the tilling area of all large stones, roots, and other debris.
 - (e) Avoid applying downward pressure on the handlebars. If necessary, apply slight upward pressure to prevent the tines from digging too deeply.
 - (f) Always avoid contacting hard-packed soil or sod at the end of a row by reducing the engine speed and lifting the handlebars to raise the tines out of the soil.
 - (g) In an emergency, stop the tines and wheels by shifting the Wheels/Tines/PTO Drive Lever into "NEUTRAL". If you cannot reach the lever or have lost control of the tiller, LET GO of the handlebars and all controls and do not attempt to restrain the tiller.
15. Do not overload the machine capacity by attempting to till too deeply at too fast a rate.
16. Never operate the tiller at high transport speeds on slippery surfaces.
17. Do not operate tiller on a slope that is too steep for safety. When on slopes, slow down and make sure you have good footing. Never permit the tiller to free-wheel down slopes.
18. Clear the area of bystanders before tilling.

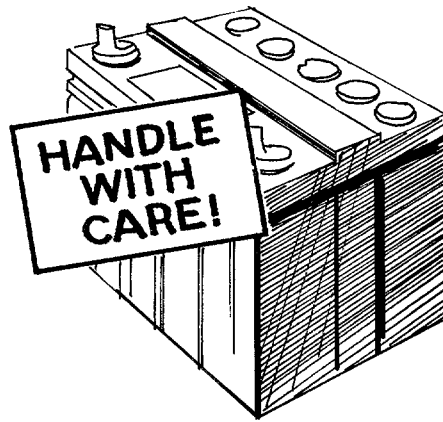

19. Use only attachments and accessories that are approved by Garden Way Manufacturing Company.

20. Use tiller attachments and accessories when recommended.

21. Never operate the tiller without good visibility or light.

22. Never operate the tiller when fatigued, or while under the influence of alcohol, drugs, or medication.

23. Do not change the engine governor settings or overspeed the engine.

24. Do not touch engine parts that may be hot from operation. Allow parts to cool before inspecting, cleaning, or repairing.

25. **POISON/DANGER—CAUSES SEVERE BURNS.** The battery on electric start models contains sulfuric acid. Avoid contact with skin, eyes or clothing. Antidote: EXTERNAL—Flush immediately with lots of water.

INTERNAL—Drink large quantities of water or milk. Follow with milk of magnesia, beaten eggs or vegetable oil. Call physician immediately.

EYES—Flush with water for 15 minutes and get prompt medical attention. Keep out of reach of children.

26. **DANGER—BATTERIES PRODUCE EXPLOSIVE GASES.** Keep sparks, flame, or smoking materials away. Ventilate when charging or using in an enclosed space. Always shield eyes when working near batteries.

27. Please Remember: You can always stop the tines and wheels by putting the Wheels/Tines/PTO Drive Lever in "NEUTRAL", or by moving the Throttle Lever to the "STOP" position. If you have lost control of the tiller, and cannot reach the levers, LET GO of the handlebars and all controls and do not attempt to restrain the tiller. The Forward Interlock Safety System will stop the engine.

28. Look behind and use care when backing. For added safety,

put Wheel Speed Lever in "SLOW" before reversing.

29. When loading or unloading unit, always disengage the tines and use slower wheel and engine throttle speeds. Use sturdy ramps that are wide and strong enough to support both the tiller and operator (tiller weighs between 280 and 325 lbs.). Never go down ramps in "FORWARD" drive as the tiller could tip forward, exposing you to the tines (which should be disengaged). Always use "REVERSE" drive and back down ramps. To go up ramps, use "FORWARD" drive and follow tiller up ramps.

30. The Forward Interlock Safety System should first be tested for proper functioning every time the tiller or PTO Power Unit is used. See Section 3 in this Manual for the testing procedure to follow.

31. When snowplowing with the optional dozer blade, either remove the tines completely, or disengage the tines with the Tines/PTO Clutch Lever. Revolving tines could be dangerous on slippery sidewalks or driveways.

MAINTENANCE AND STORAGE

1. Never perform any maintenance while the engine is running or the spark plug wire is connected, except where specifically instructed to do so.

2. Keep machine, attachments and accessories in safe working condition.

3. Check all nuts, bolts, and screws at frequent intervals for proper tightness and to be sure the equipment is in safe working condition.

4. Never store the machine with fuel in the fuel tank inside a building where fumes may reach an open flame or spark, or where igni-

tion sources are present (such as hot water and space heaters, furnaces, clothes dryers, stoves, electric motors, etc.).

5. Allow the engine to cool before storing in any enclosure.

6. To reduce fire hazard, keep the engine free of grass, leaves or excessive grease.

7. Store gasoline in a cool, well-ventilated area, safely away from any spark or flame-producing equipment. Store gasoline in an approved container, safely out of the reach of children.

8. Refer to the Maintenance and Service Section of this Manual if the tiller is to be stored for an extended period.

DECALS

Safety decals and operating instruction decals are located on the handlebars, the operator control panel, the tine hood, the engine, and the transmission. Contact us immediately for replacement decals if any are missing, illegible, or damaged. See your Parts Catalog for the exact location and part number of each decal. Do not attempt to operate machine if any decals are illegible or missing.

SECTION 2: Controls and Functions

Before using your tiller or PTO Power Unit for the first time, become thoroughly familiar with the operation of the controls by moving them to their various positions

while the engine is not running. Taking the time now to fully understand the location, function, and operation of these controls will greatly add to the productive use,

safe operation, and full enjoyment of your new machine. The proper operation of each control is discussed in detail in this Section.

Tiller and PTO Power Unit Controls

1. Wheels/Tines/ PTO Drive Lever

This lever engages power from the engine to the transmission (see Photos 2-1, 2-2, and 2-3). There are three positions of this lever: "FORWARD", "NEUTRAL" and "REVERSE":

When you move the lever down to the "FORWARD" position, it raises the engine upward and tightens the drive belt located between the engine pulley and the transmission pulley. The transmission then

drives the wheels and tines in a forward direction. (If the tines are removed and replaced with a PTO driven attachment, the lever will apply power to the attachment.) The lever will remain in "FORWARD" until you tap or lift it upward and let it go.

When you move the lever all the way up to the "REVERSE" position, it lowers the engine and causes the drive belt to go slack. At the same time, the rubber reverse disc on the engine pulley comes into contact with the transmission pulley, causing the transmission to rotate the wheels and tines (or any PTO driven attachment) in a reverse direction. The reverse operation will continue as long as you hold the lever up. When you release the lever, it will automatically return to "NEUTRAL". This is a safety feature for your protection.

When the lever is in "NEUTRAL", the engine will continue to run, but power will not be transferred to the transmission.

To operate the Wheels/Tines/ PTO Drive Lever:

A. Practice shifting the lever as described next. As you do, note in the accompanying photos the various positions that the clutch roller takes on the belt adjustment block. Your roller should be similarly positioned when you shift the lever.

B. For forward motion of the wheels and tines (or to apply power to any PTO driven attachment), push the lever all the way down and release it. See Photo 2-1. To return to "NEUTRAL", tap or lift the lever up and let it go (Photo 2-2).

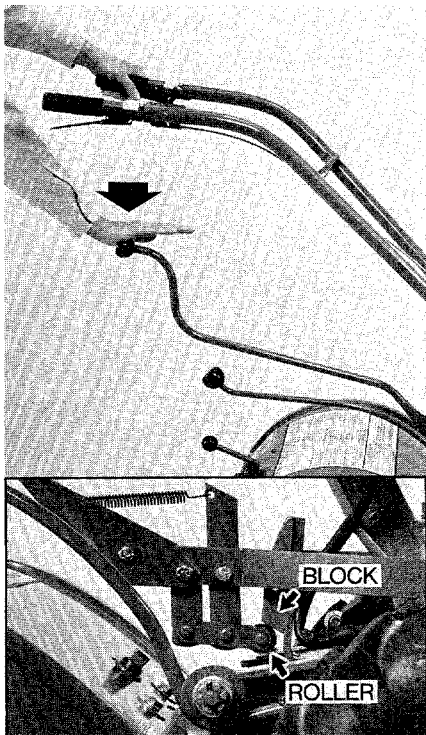

2-1: Push lever down for "FORWARD". The clutch roller (lower photo) will be engaged below the adjustment block.

IMPORTANT
Moving the lever to the "NEUTRAL" position will stop all wheel and tine motion, or power to any PTO driven attachment.

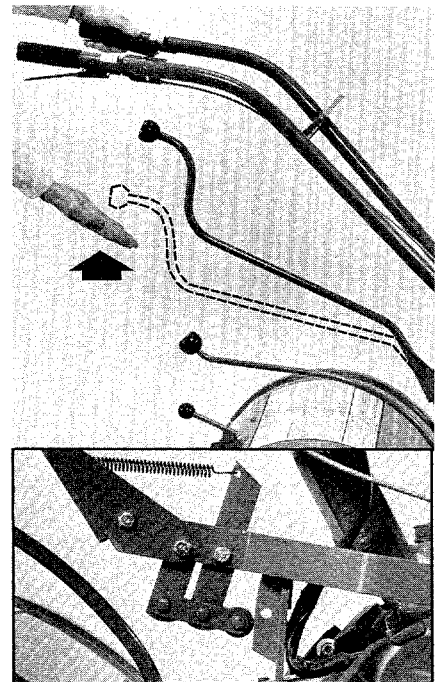

2-2: Tap or lift lever up to return to "NEUTRAL". The clutch roller (lower photo) will rest anywhere on the face of the adjustment block, depending upon drive belt length and tension.

C. Before shifting into “REVERSE”, always look behind you to make sure there are no obstacles in the way. Then raise the tines out of the soil by lifting up on the handlebars, and *slowly lift* the lever all the way up. See Photo 2-3. To return to “NEUTRAL”, simply let go of the lever.

Please remember that you should *never till* when in “REVERSE” (always disengage the tines with the separate Tines/PTO Clutch Lever before reversing). You should also avoid using “REVERSE” with any PTO driven attachments as they are not designed for reverse operation.

Until you are completely comfortable with handling the machine when it is moving backward, it is a good idea to use “REVERSE” only at slower wheel and engine throttle speeds. Many people never shift into “REVERSE” when the separate Wheel Speed Lever is in the “FAST” wheel speed position. This is a good rule to follow.

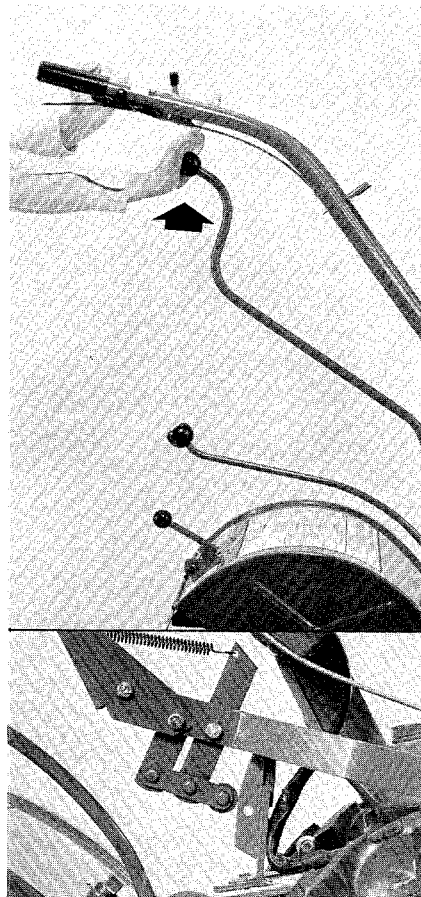

2-3: Lift handlebars, then lift and hold lever up to go in reverse. Let go of lever to stop reverse motion. (Note that the clutch roller doesn't move very far from “NEUTRAL” to “REVERSE”.)

CAUTION

TO AVOID PERSONAL INJURY OR DAMAGE TO EQUIPMENT:

- Always place the Wheels/Tines/PTO Drive Lever in “NEUTRAL” before starting the engine, and before engaging the wheels, tines or other PTO driven attachments.
- Always make sure there are no obstacles behind you before operating in “REVERSE”.
- The Wheels/Tines/PTO Drive Lever should automatically return to “NEUTRAL” when you release it from the “REVERSE” position. If it fails to do so, push it down into “NEUTRAL”. Then, immediately refer to Section 6 of this Manual for adjustment instructions.
- There should not be any reverse motion if the Wheels/Tines/PTO Drive Lever is not held in the “REVERSE” position. If there is, the machine is badly out of adjustment and it should not be operated until the condition is corrected. See Section 6 for adjustment instructions.
- Always return to “NEUTRAL” and allow all motion to stop before shifting into “FORWARD” or “REVERSE”. This pause between shifting will protect the drive belt, reverse disc, and other transmission components from undue wear and damage.

2. Forward Interlock Levers

There are two Forward Interlock Levers, one located directly below each handlebar grip. See Photo 2-4. One or both of the interlock levers must be kept squeezed against the handlebar grip(s) whenever the Wheels/Tines/PTO Drive Lever is engaged in “FORWARD”.

If you release both interlock levers before first returning the Wheels/Tines/PTO Drive Lever to “NEUTRAL”, the engine will shut off. *This is a safety feature for your protection should you ever lose control of the machine and cannot stop forward motion by moving the Wheels/Tines/PTO Drive Lever into “NEUTRAL”.*

NOTE: The interlock levers do not affect operation when the Wheels/Tines/PTO Drive Lever is in “REVERSE”.

To operate the Forward Interlock Levers:

- Squeeze one of the interlock levers against the handlebar grip before engaging the Wheels/Tines/PTO Drive Lever in “FORWARD”. Continue to squeeze one or both of the interlock levers during all forward operation.
- To stop forward operation in normal use, first shift the Wheels/Tines/PTO Drive Lever into “NEUTRAL” and then release BOTH interlock levers. All forward motion will stop, but the engine will continue to run.
- To stop forward motion in an emergency, release BOTH interlock levers. This will cause the engine to shut off, stopping all forward motion.

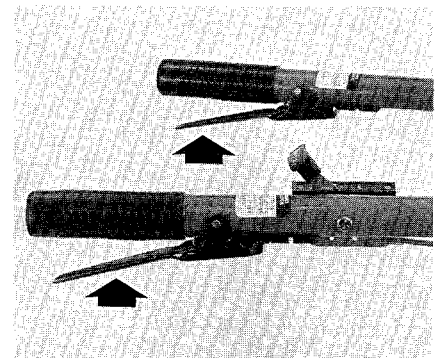

2-4: The Forward Interlock Levers.

WARNING

To help avoid personal injury, the Forward Interlock Safety System should first be tested for proper functioning every time the tiller or PTO Power Unit is used. See Section 3 in this Manual for the easy testing procedure to follow.

3. Wheel Speed Lever

This lever allows you to choose between two different wheel ground speeds: “SLOW” or “FAST”. It also has a “FREE WHEEL” position, in which the wheels are free to turn without the engine running. See Photo 2-5.

When the lever is engaged in either “SLOW” or “FAST” and the Wheels/Tines/PTO Drive Lever is in either “FORWARD” or “REVERSE”, the wheels will turn under engine power.

When the lever is in the “FREE WHEEL” position and the Wheels/Tines/PTO Drive Lever is in “NEUTRAL”, the machine can be moved (on level ground) by pushing or pulling on the handlebars. The “FREE WHEEL” position is also used when you are operating a PTO driven stationary attachment, in which case you would not want the wheels to move when the Wheels/Tines/PTO Drive Lever is engaged in “FORWARD”.

IMPORTANT

By moving the forward drive belt (see “Changing Belt Speeds” in Section 3) into one of two different belt ranges, you can obtain a total of four different forward wheel ground speeds. There are, however, only two reverse wheel ground speeds (“SLOW” or “FAST”), because the rubber reverse disc, not the drive belt, drives the wheels in the reverse direction.

When you shift the lever into “SLOW” or “FAST”, it moves a sliding clutch inside the transmission to the left or right to engage the slow speed wheel gear or the fast speed wheel gear. When engaging the clutch, you should roll the wheels forward or backward a few inches to help align the clutch with

the selected wheel gear. When the clutch goes into gear, you will no longer be able to roll the wheels.

When you shift the lever into “FREE WHEEL”, the sliding clutch is disengaged from both wheel gears and the wheels will roll freely. Note that there should not be any “clicking” noise when you’re in “FREE WHEEL”. If there is, shift the lever a little more (either up or down) to eliminate the noise—and the rubbing of the clutch and gear that causes it.

To operate the Wheel Speed Lever:

A. With the Wheels/Tines/PTO Drive Lever in “NEUTRAL”, roll the wheels a few inches in either direction while you push the Wheel

Speed Lever down to the “SLOW” position, or up to the “FAST” position. See Photo 2-5. When the lever is in gear, you will no longer be able to roll the wheels.

B. With the Wheels/Tines/PTO Drive Lever in “NEUTRAL”, move the Wheel Speed Lever in between the “SLOW” and “FAST” wheel speed positions to place the wheels in “FREE WHEEL”.

CAUTION

TO AVOID PERSONAL INJURY OR DAMAGE TO EQUIPMENT:

- Use the “SLOW” wheel speed position when first learning to operate the machine and whenever you operate in “REVERSE”.
- Do not shift the Wheel Speed Lever when heading up or down a slope. If the lever is accidentally placed in “FREE WHEEL”, the machine could roll out of control.
- Place the Wheels/Tines/PTO Drive Lever in “NEUTRAL” before shifting into “SLOW” or “FAST”. This will prevent damage to the clutch or wheel speed gears.
- Do not attempt to stop the wheels by shifting the Wheel Speed Lever. Always put the Wheels/Tines/PTO Drive Lever in “NEUTRAL” to stop the wheels.

WARNING

Never put revolving tines in the soil when the Wheel Speed Lever is in “FREE WHEEL”. Doing so can cause the tiller to be propelled rapidly by the tines, possibly causing loss of control and serious personal injury. Always engage the Wheel Speed Lever in either “SLOW” or “FAST” wheel speed before putting the tines in the soil.

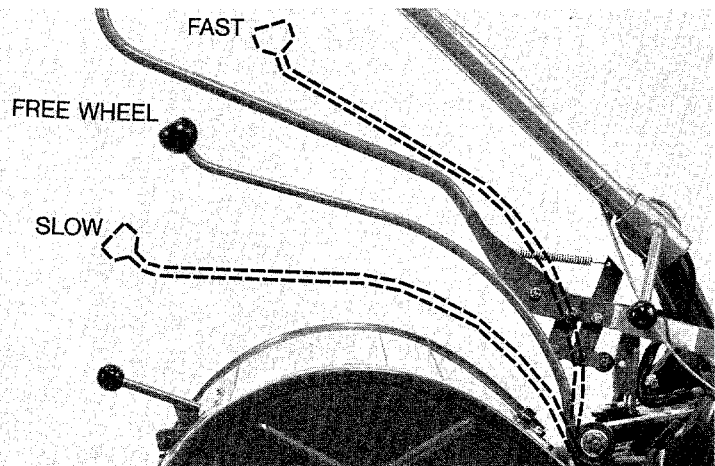

2-5: The Wheel Speed Lever.

4. Tines/PTO Clutch Lever

This lever is located on the left side of the transmission, just forward of the tiller tine hood. There are two operating positions: “ENGAGE” and “DISENGAGE”. See Photo 2-6.

When you move the lever to the “ENGAGE” position, it moves the “dog” clutch on the PTO Power Unit drive shaft backward until it engages the “dog” clutch on the tine attachment drive shaft. (If the tines are removed and replaced with a PTO driven attachment, the “dog” clutch on the power unit will engage with the “dog” clutch on the PTO driven attachment). Engine power will then be applied to the tines or PTO driven attachment when the separate Wheels/Tines/PTO Drive Lever is engaged in “FORWARD” or “REVERSE”.

In the “DISENGAGE” position, the “dog” clutches are disengaged, and power will not be applied to the tines or PTO attachment.

When operating the tiller, the “DISENGAGE” position allows you to stop the tines while the separately controlled wheels continue to rotate. You should use this feature whenever you are transporting, loading or unloading, turning around, or backing the tiller up. You should also disengage the lever before towing or transporting any attachment.

When the tines are removed and a PTO driven attachment that operates from a stationary position is installed, the “ENGAGE” position allows you to power the attachment while the wheels on the PTO Power Unit are not moving.

Always place the Wheels/Tines/PTO Drive Lever in “NEUTRAL” before shifting the Tines/PTO Clutch Lever. Doing so will help prevent damage to the transmission that could occur if you try to engage or disengage the separate drive shaft clutches while they are turning under power.

To operate the Tines/PTO Clutch Lever:

- A.** Put the Wheels/Tines/PTO Drive Lever in “NEUTRAL”.
- B.** Pull the Tines/PTO Clutch Lever out and then slide it into the “ENGAGE” or the “DISENGAGE” slot.
- C.** After selecting the “ENGAGE” position, do not immediately shift the Wheels/Tines/PTO Drive Lever into “REVERSE”. Always use “FORWARD” first, to help align the drive shaft clutches inside the transmission. **NOTE:** The lever should move easily. If it doesn't, then the “dog” clutch inside the PTO Power Unit transmission may need to be lubricated. See “Tiller Lubrication” in Section 6 of this Manual.



CAUTION

TO AVOID PERSONAL INJURY OR DAMAGE TO EQUIPMENT:

- Always disengage the Tines/PTO Clutch Lever before reversing, transporting, turning around, or loading or unloading the tiller or PTO Power Unit.
- Do not attempt to stop the tines or any PTO driven attachment by disengaging the Tines/PTO Clutch Lever. Always put the Wheels/Tines/PTO Drive Lever in “NEUTRAL” to stop all motion.
- Read the Owner/Operator Manual provided with any attachment before attempting to operate the attachment.



2-6: The Tines/PTO Clutch Lever.

5. Depth Regulator Lever

This lever is located at the rear of the tine hood—see Photo 2-7. It is used to regulate the tilling depth of the tines.

To operate the lever, pull it straight back and then slide it up or down to any of eight different notched settings.

When the lever is moved all the way down until it engages the highest notch in the lever, it places the tines in the “TRAVEL” position. In this position the tines will clear the ground by approximately 2-inches, allowing you to transport the tiller without the tines—which should be disengaged—scraping your lawn or driveway.

For shallow tilling and cultivating, you should place the lever in the second or third notch from the top. These positions will allow the tines to dig just a few inches into the soil. The remaining notches are used for deeper tilling (up to 8-inches deep, depending on the soil conditions), and for turning under organic matter.

Further details regarding the proper use of this lever will be found in Section 4 of this Manual (see “Tilling Depths”).



WARNING

To help avoid personal injury, always place the tines in the “TRAVEL” position before starting the engine. This prevents the tines from touching the ground until you are ready to begin tilling.

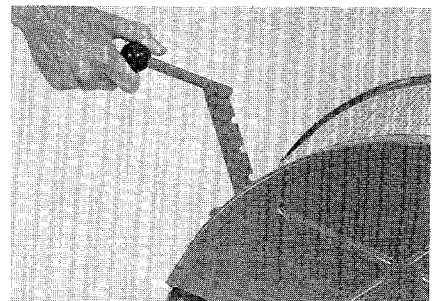

2-7: The Depth Regulator Lever.

6. Handlebar Height Adjustment Lever

This lever is located near the bottom of the handlebars, on the right side of the tiller. See Photo 2-8. It allows you to adjust the handlebars up or down to any of four different settings.

As a general rule, the handlebars should be adjusted to approximately waist level when the tines are 3 to 4-inches in the soil, but you should try different settings to find the one that is most comfortable for you.

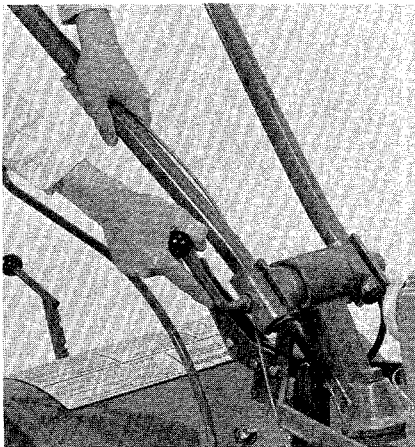

2-8: Handlebar Height Adjustment Lever.

To operate the Height Adjustment Lever:

- A. Stop the engine before adjusting the handlebars.
- B. Support the handlebars with one hand while unwinding the lever enough so that the teeth in the ratchets are disengaged.
- C. Move the handlebars up or down to either of two preset height adjustment settings and then re-tighten the lever securely.
- D. Two additional height settings can be obtained by switching the inside handlebar ratchets, as shown in Figure 2-9. This will change the handlebar height a few inches higher or lower than the lowest setting obtained in Step C.

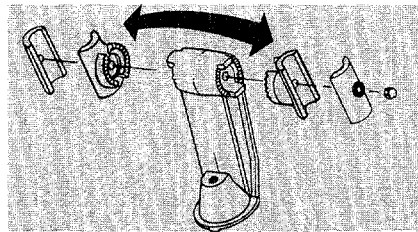

2-9: Switch ratchets to obtain two more height settings.

WARNING

For use with the PTO Chipper/Shredder Attachment only, the handlebars can be swung 30° to the right side by loosening the mounting bolt at the bottom of the handlebar base. NEVER OPERATE THE TILLER OR OTHER ATTACHMENTS WITH THE HANDLEBARS SWUNG OUT TO THE RIGHT SIDE. Doing so could result in unsafe handling and personal injury.

ENGINE CONTROLS

The following are descriptions of the controls on your 7 HP Briggs & Stratton Engine or 8 HP Kohler Engine. Additional information on the safe, efficient operation of your engine is given in the engine manufacturer's Owner's Manual which was included in your literature package. Please read that literature carefully and save it for future reference.

WARNING

To avoid personal injury or damage to equipment, do not attempt to start your engine at this time. Complete starting instructions for the engine are given in Section 3, "Operation of Tiller."

1. Engine Throttle Lever

This lever is located on the right side handlebar (see Photo 2-10). It is used to regulate engine speeds

as well as to start and stop the engine.

In general, faster engine speeds will be required when breaking new ground or tilling under heavy crop residues, but remember to use only as fast an engine speed as is needed to do the job. Try to judge when the engine is providing the proper amount of power—not too little, but not too much. The sound of the engine running will be your best guide.

IMPORTANT

Factory settings of the throttle cable should be satisfactory for most conditions. If adjustments are needed, refer to Section 6 of this Manual.

To operate the Engine Throttle Lever:

- A. When starting the engine, first make certain that the Wheels/Tines/PTO Drive Lever is in "NEUTRAL". Then, place the lever approximately halfway between the "SLOW" and "FAST" throttle settings. This position should provide the carburetor with sufficient gasoline flow to start the engine. However, you may need to experiment the first few times to find that "just right" starting position.
- B. For faster engine speeds move the lever forward toward the "FAST" setting; for slower speeds

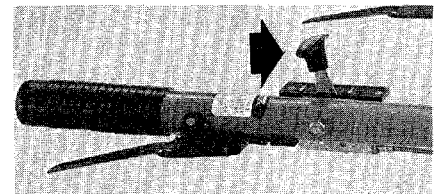

2-10: The Engine Throttle Lever.

move it backward toward the "SLOW" setting.

- C. To stop the engine, move the lever all the way back to the "STOP" position (during normal operation you would first place the Wheels/Tines/PTO Drive Lever in "NEUTRAL" and then release both Forward Interlock Levers before stopping the engine).

2. Engine Choke Control

Your engine is equipped with a manually operated choke control as shown in Photo 2-11 or 2-12. The choke makes starting a cold engine easier by decreasing the amount of air in the carburetor's air-fuel ratio, thus creating a richer fuel mixture. The use of the choke for starting will vary, depending on air temperature and altitude.

To operate the Choke Control:

A. Before starting a cold engine, set the choke in the "FULL CHOKE"

position. On the 7 HP Briggs & Stratton Engine, move the lever all the way down. On the 8 HP Kohler Engine, move the lever all the way up.

B. When the engine starts, slowly move the lever to the "CHOKE OFF" position (all the way up for the 7 HP Briggs & Stratton Engine; all the way down for the 8 HP Kohler Engine).

C. If the engine should falter with the choke at "CHOKE OFF", return

the lever to a position halfway between "FULL CHOKE" and "CHOKE OFF". As soon as the engine runs smoothly, return the lever to "CHOKE OFF".

D. When restarting an already warm engine, you may not have to use the choke at all. However, if the engine falters or hesitates, try using a "HALF CHOKE" position until it runs smoothly, and then return the lever to "CHOKE OFF".

CAUTION

Never operate the engine under a load (tines, wheels, or PTO attachments engaged) without first returning the choke control to "CHOKE OFF". Failure to do so can quickly build up carbon deposits that can harm the engine.

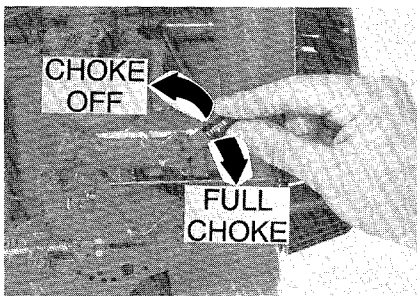

2-11: Choke control on 7 HP Engine.



2-12: Choke control on 8 HP Engine.

3. Engine Recoil Starter

The recoil starter is located at the front of the engine, as shown in Photo 2-13 or 2-14. It is used to start engines that are not equipped with the optional key switch starting feature.

To operate the Engine Recoil Starter:

A. When starting the engine, first make certain that the Wheels/Tines/PTO Drive Lever is in "NEUTRAL".

B. Place your free hand in the location shown in Photo 2-13 or 2-14 to help stabilize the machine.

C. Grasp the starter rope handle with your other hand and pull the

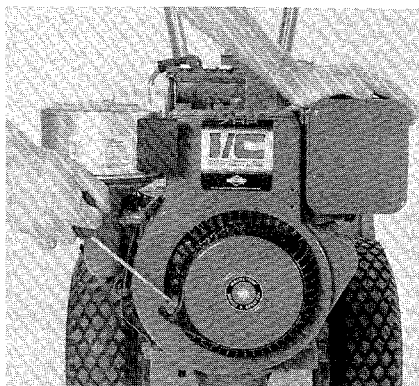

2-13: Starting the 7 HP Briggs & Stratton Engine.

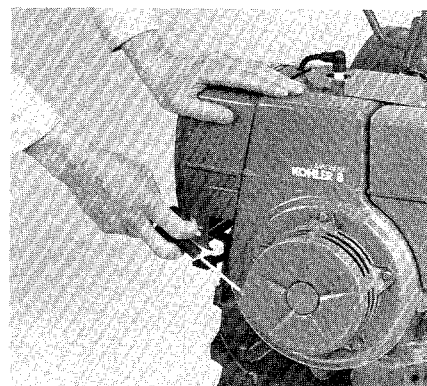

2-14: Starting the 8 HP Kohler Engine.

handle out slowly until it is harder to pull because of engine compression. Then pull the handle with a rapid, continuous, full-arm stroke. Let the starter rope rewind slowly after each start attempt.

WARNING

To help avoid personal injury, be sure that the area behind you is clear before pulling the starter rope.

4. Key Switch Starter

The key switch starter for the optional electric start engine is located on the right side of the battery hold-down clamp, as shown in Photo 2-15. There are three operating positions identified on the switch: "OFF", "RUN" and "START".

When the key is turned to the "START" position, the battery supplies an electrical current to the engine's starter motor which then cranks the engine over at a fast enough speed for starting.

During engine operation, the battery is recharged automatically via a small recharging current that the engine sends back to the battery through the electrical system's recharging line.

If the electrical system should ever fail to start or stop the engine,

refer to the "Electric Start Troubleshooting" instructions found in Section 6 of this Manual.

To operate the Key Switch Starter:

A. When starting the engine, first make certain that the Wheels/Tines/PTO Drive Lever is in "NEUTRAL". Also remember to set the Engine Throttle Lever in the starting position and the Choke Control in the "FULL CHOKE" position (for cold starts).

B. Insert the key firmly into the key switch slot and turn it all the way to the right, to the "START" position. When the engine starts, release the key and it will automatically return to the "RUN" position. *Do not hold the key in the "START" position for longer than a*

few seconds. Prolonged cranking can damage the starter motor if it is cranked more than 15 seconds per minute.

C. There are two ways to stop the engine:

- (1) Put the Wheels/Tines/PTO Drive Lever in "NEUTRAL", release both Forward Interlock Levers, and then pull the throttle lever all the way back to the "STOP" position. Turn the key to "OFF" and remove the key.
- (2) Put the Wheels/Tines/PTO Drive Lever in "NEUTRAL", release both Forward Interlock Levers, and then turn the key to "OFF". Put the throttle lever in the "STOP" position and remove the key.

NOTE: To stop forward motion in an emergency, release both Forward Interlock Levers. This will cause the engine to shut off.

IMPORTANT

If the battery will not be used for extended periods of time, it should be fully charged before placing it in storage. Before reinstalling the battery after storage, give it a thorough recharge. See "Battery Care and Maintenance" in Section 6 for charging instructions.

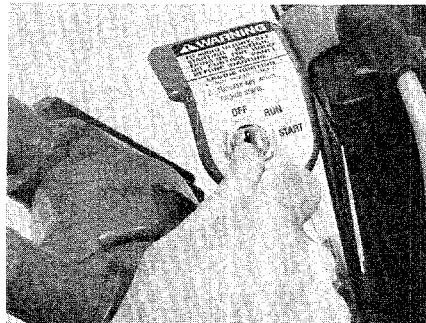

2-15: The Key Switch Starter.

WARNING

To avoid injury due to accidental or unauthorized engine starting, always remove the key from the switch when leaving the machine unattended.

5. Fuel Tank Shut-Off Valve

Your engine is equipped with a fuel tank shut-off valve. It is located underneath the gasoline tank. See Photo 2-16 or 2-17.

This valve stops the flow of gasoline from the fuel tank to the carburetor. Before starting, make sure that the valve is in its OPEN position (rotate counterclockwise several turns) or the engine will quit from lack of fuel shortly after you start it.

NOTE: Close fuel shut-off valve when engine is transported to prevent fuel leakage from carburetor.

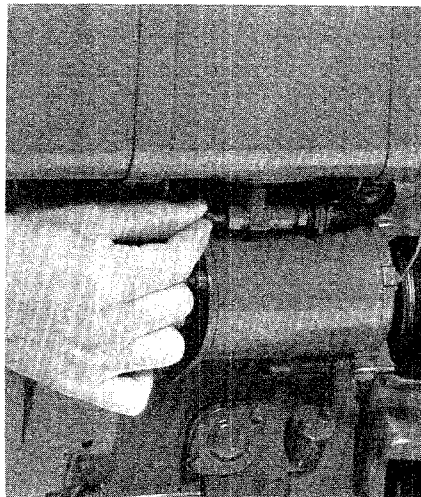

2-16: Fuel shut-off valve on 7 HP Briggs & Stratton Engine.

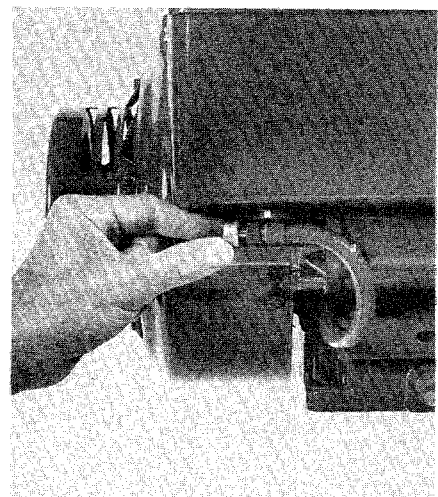

2-17: Fuel Shut-off valve on 8 HP Kohler Engine.

SECTION 3: Operation of Tiller

Before you attempt to operate your tiller make sure that you've read and fully understand all of the Safety instructions in Section 1 and the Controls information in Section 2. You should also read this Section carefully before starting your engine.

You should practice with your tiller in an open, level area before you use it in your garden. While practicing, do so without the tines revolving (disengage the tines with the Tines/PTO Clutch Lever).

When you've become completely familiar with your tiller, you can begin using it in your garden.



WARNING

To avoid personal injury or damage to equipment, read the Owner/Operator Manuals provided with any optional accessories or attachments before operating the tiller or PTO Power Unit. The Manuals provide a detailed description of proper use and operation, and point out other important Safety Instructions.

Break-in operation

During the first few hours of new machine operation, you must perform the following maintenance. For subsequent required maintenance, and the procedures to follow, please refer to Section 6 in this Manual.

- 1. CHANGE ENGINE OIL.** The engine oil must be changed after the first 5 hours of new engine operation. Thereafter, change the oil after each 10 operating hours. Change the oil more frequently when operating in extremely dusty or dirty conditions.
- 2. CHECK TRANSMISSION GEAR OIL LEVEL.** The gear oil levels must be checked after the first 2 hours of new tiller operation. Thereafter, check the oil levels after every 30 operating hours.

- 3. CHECK DRIVE BELT TENSION.** The tension on the drive belt may need to be adjusted after the first 2 or 3 hours of new operation due to initial belt wear and seating of the belt with its pulleys. Thereafter, check the tension after every 10 operating hours.
- 4. CHECK BOLTS AND NUTS.** Check for loose bolts and nuts after the first 2 hours of new tiller operation. Thereafter, check after every 10 operating hours.

Preparation before starting

Make the following checks and perform the services as required before starting the engine.

- 1. CHECK ENGINE OIL LEVEL.** Check the oil level in the engine crankcase. Do not run the engine unless the proper oil level is maintained.
- 2. SERVICE AIR CLEANER.** Make sure that the air cleaner elements are not dirty.
- 3. CHECK SAFETY GUARDS.** Make sure that all safety guards and covers are securely in place.
- 4. ATTACH SPARK PLUG WIRE.** Be sure that the spark plug wire is securely attached to the spark plug.
- 5. CHECK ENGINE COOLING SYSTEM.** The cooling fins and air intake screen must be clean to ensure adequate cooling.
- 6. ADJUST HANDLEBARS.** Set the handlebars to a comfortable operating height.
- 7. CHECK BATTERY (Electric Start Models).** Make sure that the battery is properly filled and that all electrical connections are clean and tight.
- 8. FILL FUEL TANK WITH GASOLINE.** Avoid using gasoline that is not fresh, as stale fuel can cause gum deposits to form in the carburetor and fuel lines. Fuel should not be stored for more than six months. The use of unleaded gasoline is recommended as it results in fewer combustion deposits and longer engine life. **DO NOT MIX OIL WITH THE GASOLINE.**
 - (a) Clean the fuel cap and its surrounding area before removing the cap.
 - (b) Use a clean funnel to add fuel to the fuel tank.
 - (c) Do not fill the tank to the point of overflowing. Fill to within ½-inch of the top of the tank to prevent spills and to allow for fuel expansion.
 - (d) For 7 HP Briggs & Stratton Engines: use clean, fresh, lead-free automotive gasoline (leaded gasoline may be used if unleaded is unavailable). Use gasoline that has a minimum octane rating of 77. Do not use gasoline containing Methanol. The use of gasoline which contains alcohol (such as gasohol) is not recommended. If you are

using gasohol, refer to the Briggs & Stratton Operating and Maintenance Instructions booklet for specific cautions and recommendations for this type of fuel.

(e) For 8 HP Kohler Engines: use fresh, clean, unleaded regular automotive gasoline with a pump sticker octane rating of 87 or higher.

(Leaded "Regular" grade gasoline is an acceptable substitute). The fuel tank capacity is 1¼ gallons.

(f) Replace the fuel cap securely before starting the engine.



DANGER

GASOLINE IS HIGHLY FLAMMABLE AND ITS VAPORS ARE EXPLOSIVE. FOLLOW THESE SAFETY PRACTICES TO PREVENT INJURY FROM FIRE OR EXPLOSION!

- Never fill tank when engine is running or still hot from operation. Allow engine and muffler to cool at least 2 minutes before refueling.
- Do not allow open flames, sparks, matches or smoking in the area.
- Fill fuel tank outdoors in a well-ventilated area. Wipe up any spills and move tiller away from gasoline fumes before starting engine.
- Use only an approved gasoline container and store safely out of reach of children.
- Store gasoline and tiller in a well-ventilated area. Do not store where vapors may reach an open flame or spark, or where ignition sources are present (such as hot water and space heaters, furnaces, clothes dryers, stoves, electric motors, etc.)
- Allow engine to cool before storing in any enclosures.
- Never bring a gasoline can near the battery posts on electric start model tillers. A short circuit caused by touching the positive (+) post and any metal could cause an explosion of the gasoline or of battery gases.

Test operation of Forward Interlock Safety System

The Forward Interlock Safety System consists of an electrical grounding system that connects the two Forward Interlock Levers on the handlebars to the ignition system of the engine. One or both of the Forward Interlock Levers must be kept squeezed against the handlebar grip(s) whenever the Wheels/Tines/PTO Drive Lever is engaged in "FORWARD". If you release BOTH interlock levers before first moving the Wheels/Tines/PTO Drive Lever to "NEUTRAL", the interlock system will ground out the engine's ignition system and stop the engine. The interlock system also prevents the engine from starting if the Wheels/Tines/PTO Drive Lever is engaged in "FORWARD".

Because the interlock system is an electrical/mechanical device, it is subject to wear or possible failure. Therefore, the interlock system should be checked for proper operation each time the tiller or PTO Power Unit is used.



DANGER

The Forward Interlock Safety System is designed for your safety. Never attempt to disconnect or to otherwise defeat the purpose of this system. If the interlock system fails to operate properly, immediately contact the TROY-BILT Tiller Technical Service Department. Do not operate the tiller or PTO Power Unit until the system has been repaired and is functioning properly. Always test the system prior to each use.

How to check the interlock system:

1. Move the machine outdoors and park it on level ground. Make sure the area around you is clear of any obstacles.
2. Check to make sure that the Forward Interlock Wire Harness

plug at the bottom of the handlebars is firmly connected to the wire harness receptacle located on the top, right side of the transmission. See Photo 3-2.

3. Place the Wheel Speed Lever in "SLOW" and the Tines/PTO Clutch Lever in "DISENGAGE".

4. Start the engine as described on Pages 18-19. Set the throttle lever in a "SLOW" running position and allow the engine to warm up.

5. Squeeze one of the Forward Interlock Levers against the handlebar grip and then push the Wheels/Tines/PTO Drive Lever all the way down to "FORWARD". See Photo 3-3. As the tiller starts to move

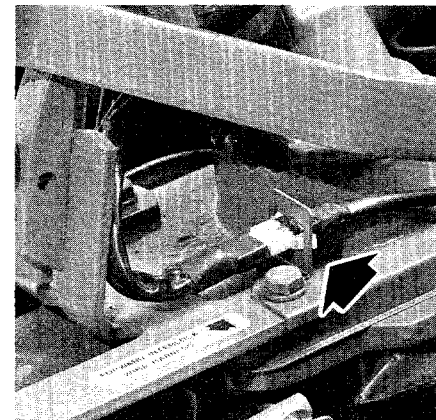

3-2: Check for good connection between plug and receptacle of Forward Interlock Safety System.

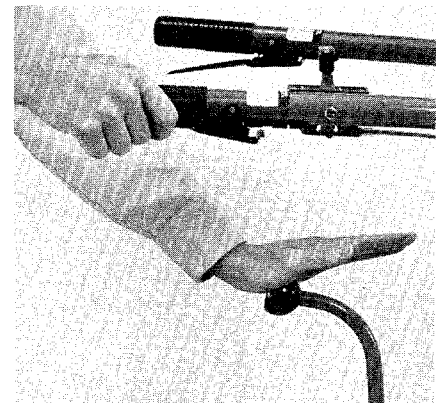

3-3: Squeeze one Forward Interlock Lever and then move Wheels/Tines/PTO Drive Lever down to "FORWARD".

forward, release the Forward Interlock Lever briefly. If the system is working properly, the engine should start to shut off when you release the lever. If it does, quickly squeeze the lever against the handlebar grip and then return the Wheels/Tines/PTO Drive Lever to the "NEUTRAL" position (tap or lift the lever up and release it). Repeat this test using the other Forward Interlock Lever.

6. If the engine does not start to shut off when the Forward Interlock Levers are released, the system is not functioning correctly, and you should stop the engine,

remove the key (on electric start models) and disconnect the spark plug wire from the spark plug. *Do not operate the tiller or PTO Power Unit again until the system is again functioning properly.* See Section 6 in this Manual for some simple troubleshooting checks you can do to correct a faulty interlock system.

IMPORTANT

To avoid possible damage to the Forward Interlock Safety System, do not use high-pressure sprays around the wire harness receptacle or neutral plunger assembly.

Starting and stopping the engine



DANGER

To avoid personal injury, do not run engine in an enclosed or poorly vented area. Engine exhaust contains carbon monoxide, an odorless and deadly gas.

To start the engine:

IMPORTANT

Use the following steps to practice starting and stopping the engine **ONLY**. Do not attempt to drive the tiller or PTO Power Unit until you have read **ALL** of the operating instructions in this Section and in Section 5.

Cold weather operation

Before operating the machine in cold weather (below 40°F) you should take the following steps to protect your engine and transmission from possible damage.

1. Use a lighter weight oil in the engine crankcase. See "Engine Oil Maintenance" in Section 6.
2. Allow the engine to warm up thoroughly before putting it under a load.
3. Use fresh, winter grade fuel (gasoline suppliers change the fuel blend seasonally).
4. Use the correct weight gear oil in the PTO Power Unit transmission. See "Transmission Gear Oil Maintenance" in Section 6.
5. While the engine is warming, place the Wheel Speed Lever in "FREE WHEEL", block the wheels to prevent them from moving, and

- put the Tines/PTO Clutch Lever in "DISENGAGE". Then squeeze one of the Forward Interlock Levers against the handlebar grip and shift the Wheels/Tines/PTO Drive Lever into "FORWARD". This will rotate the drive shaft inside the transmission and help to warm the transmission gear oil.
6. Do not try to move the machine if the wheels are frozen to the ground. First melt the ice with warm water.

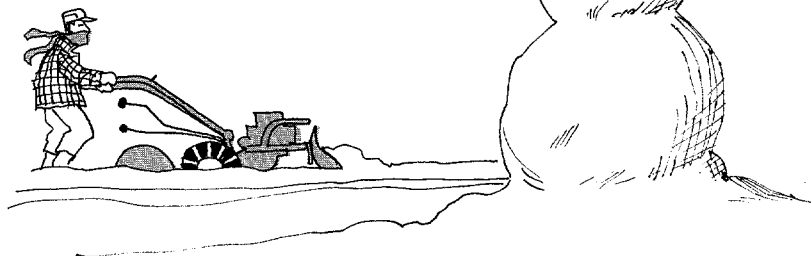

1. Place the Wheels/Tines/PTO Drive Lever in "NEUTRAL" (Photo 3-4). To find "NEUTRAL" (while the engine is not running), push the lever down until it engages in "FORWARD". Then tap or lift the lever up and release it.
2. Lower the Depth Regulator Lever until the tines are off the ground (Photo 3-4).
3. Put the Wheel Speed Lever in either "SLOW" or "FAST" (Photo 3-4). *Be sure to roll the wheels while shifting the lever until the wheels are engaged.*

- NOTE: If using a PTO driven stationary attachment, put lever in "FREE WHEEL" and place blocks around all wheels to prevent equipment from moving.
4. Move the engine throttle lever forward, away from the "STOP" position (Photo 3-4).
 5. Put the Tines/PTO Clutch Lever in the "DISENGAGE" position—Photo 3-4. (Use the "ENGAGE" position if you want the tines to turn or if you want to apply power to a PTO driven stationary attachment).
 6. Move the choke control to the "FULL CHOKE" position (Photo 3-5 or 3-6). NOTE: A warm engine may start without choking.

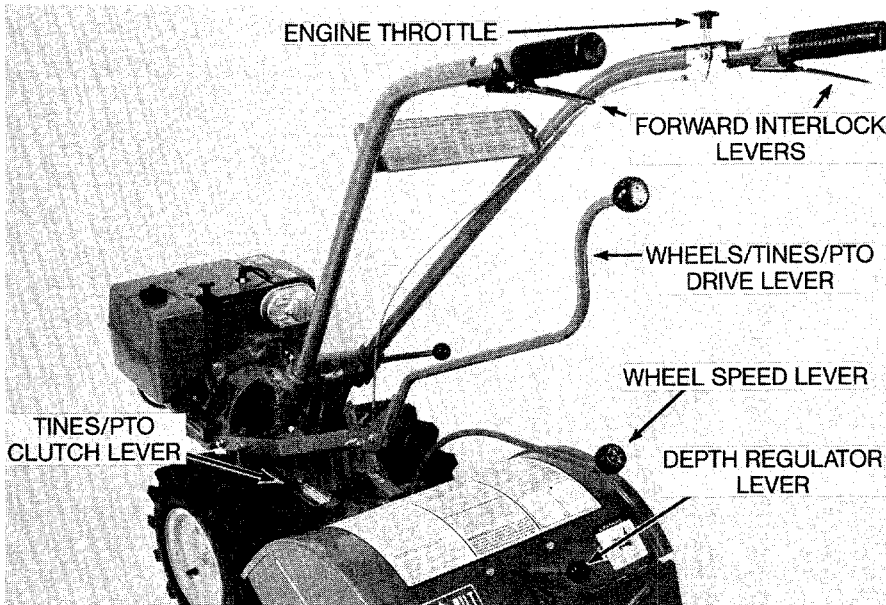

3-4: Tiller and engine controls.

NOTE: Be sure that fuel tank shut-off valve (see Page 15) is in "OPEN" position.

7. For recoil start engines:

- (a) Stabilize machine by placing your free hand on the fuel tank of the Briggs & Stratton Engine or on the air cleaner cover of the Kohler Engine.
- (b) Use your other hand to slowly pull the starter rope until you feel resistance. Then rapidly pull the rope. (Look behind you before pulling rope out.) Let the rope rewind slowly after each start attempt.

8. For electric start engines:

- (a) Turn the key to the "START" position. Do not hold the key at "START" for longer than a few seconds as prolonged cranking can damage the starter

motor if cranked more than 15 seconds per minute.

- (b) When the engine starts, release the key and it will return to the "RUN" position.

9. If the engine fails to start in four or five tries, let the engine set for 10 minutes and repeat the starting procedure.

10. When the engine starts, slowly move the choke control (if used) to the "HALF CHOKE" and then to the "CHOKE OFF" positions.

11. Move the throttle lever to the "SLOW" position and let the engine warm up.

STOPPING THE ENGINE:

- 1.** To stop the wheels and tines at any time, move the Wheels/Tines/PTO Drive Lever into the "NEUTRAL" position and then release both Forward Interlock Levers.

- 2.** Move the engine throttle lever to the "STOP" position (and turn the key to "OFF" on electric start models). *Remove the key for safekeeping.*

IMPORTANT

If turning the key to "OFF" or moving the throttle lever to "STOP" does not shut the engine off, you can move the choke control to the "FULL CHOKE" position. This will flood the engine and cause it to stall. Use this procedure only in emergencies, as continued use can be harmful to your engine.

Starting the Electric Start Engine with the recoil starter rope

If necessary, the electric start engine can be started with the recoil rope. However, before doing so be sure to follow the procedure below that applies to your particular situation.

- 1.** If the battery is in good condition (not "dead" or damaged), you can leave it on the tiller which allows it to be recharged during engine operation. But, before starting the engine with the recoil rope, make sure that the battery is filled to the correct level with electrolyte and that all of the cables and wires are properly connected.

- 2.** If the battery is "dead" or damaged, then it should be removed from the tiller and tested by a qualified battery mechanic. While the battery is removed, keep the loose terminal on the positive (+) battery cable (if cable is still attached to solenoid) covered with a wrapping of electrical tape and secure the cable to the frame of the battery bracket. This will prevent any possibility of sparking from the cable terminal.

- 3.** Before starting the engine with the recoil starter rope, place the key switch in the "RUN" position, the engine throttle lever in the "START" position, and the choke control in the "FULL CHOKE" position (for cold starts).

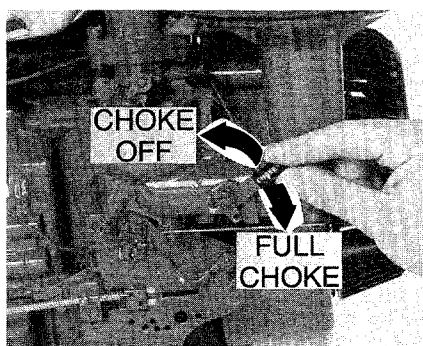

3-5: Choke control on 7 HP Engine.

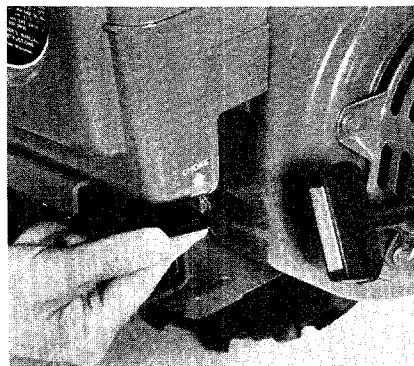

3-6: Choke control on 8 HP Engine.

To operate the tiller

Now that you are familiar with the operation of your engine, follow these steps for operating your tiller. When first practicing with your tiller, please leave the Tines/PTO Clutch Lever in the "DISENGAGE" position and put the Wheel Speed Lever in the "SLOW" wheel speed position.

WARNING

To avoid personal injury, keep hands, feet, legs and clothing away from the revolving tines.

To begin tilling:

1. Start the engine by following the previous engine starting instructions. Be certain that the Wheels/Tines/PTO Drive Lever is in "NEUTRAL" before starting the engine.
2. Test operation of Forward Interlock Safety System. See page 17.
3. Set the Depth Regulator Lever to the desired digging depth and increase the engine throttle speed (when practicing with the tiller leave the tines in the "TRAVEL" position).
4. Move the Tines/PTO Clutch Lever to the "ENGAGE" position (when practicing with the tiller leave the tines in the "DISEN-

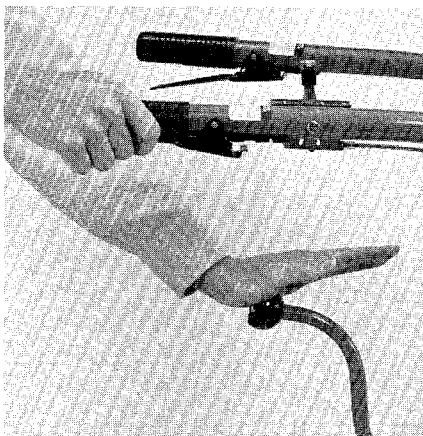

3-7: Squeeze one Forward Interlock Lever before engaging Wheels/Tines/PTO Drive Lever in "FORWARD".

GAGE" position).

5. For FORWARD MOTION of the wheels and tines, squeeze and hold one of the Forward Interlock Levers (see Photo 3-7) against the handlebar grip and then move the Wheels/Tines/PTO Drive Lever down into "FORWARD".
6. As the tiller moves forward, relax and let the wheels pull the tiller along while the tines do the digging. Walk behind and to one side of the tiller (walk on the side that is not yet tilled to avoid making footprints in the freshly tilled soil), and lightly, but securely, grip the handlebars with one hand. See Photo 3-8.

Allow the machine to work at its own pace. Pushing it forward in an attempt to make it go faster will only make the tiller harder to control. Also, please do not push down on the handlebars in an attempt to force the tiller to dig deeper. Doing so takes the weight off the wheels, reduces traction, and causes the tines to attempt to propel the tiller instead of just digging. This can



3-8: Guide tiller with one hand.

cause the tiller to hop and skip rapidly across the garden.

7. TO STOP FORWARD MOTION: Tap or lift the Wheels/Tines/PTO Drive Lever up to "NEUTRAL" and then release BOTH Forward Interlock Levers.
8. TO STOP FORWARD MOTION IN AN EMERGENCY: Let go of ALL handlebar control levers (this will shut off the engine).
9. For REVERSE MOTION:
 - (a) Do not till while in "REVERSE".
 - (b) Put the Wheels/Tines/PTO Drive Lever in "NEUTRAL" and reduce the engine throttle speed. Make sure the area behind you is clear.
 - (c) Put the Wheel Speed Lever in the "SLOW" position.
 - (d) Put the Tines/PTO Clutch Lever in "DISENGAGE".
 - (e) Lift the handlebars until the tines clear the ground and then lift and hold the Wheels/Tines/PTO Drive Lever all the way up (you do not need to squeeze a Forward Interlock Lever while in "REVERSE").

CAUTION

TO HELP AVOID PERSONAL INJURY OR DAMAGE TO EQUIPMENT:

- Always make sure there are no obstacles behind you before operating in "REVERSE".
- Disengage the tines, reduce the engine throttle speed and move the Wheel Speed Lever into the "SLOW" position before operating in "REVERSE". Avoid using "FAST" wheel speed until you are sure you can control the machine at this faster speed.

10. TO STOP REVERSE MOTION: Release the Wheels/Tines/PTO Drive Lever and it will automatically return to the "NEUTRAL" position. (The Forward Interlock Levers will not stop "REVERSE" motion.)

TO STOP THE ENGINE:

Move the engine throttle lever to the "STOP" position (and turn the key to "OFF" on electric start models). *Remove the key for safe-keeping.*

Turning around

It's easy to turn your tiller around. All you have to do is find the balance point between the engine and the tines and then let the power driven wheels do the work as you push sideways on the handlebars in the direction of your turn.

Practice the following maneuver in a large open area before taking your tiller into the garden.

WARNING

To help avoid personal injury, always put the Tines/PTO Clutch Lever in the "DISENGAGE" position before turning the tiller around.

1. At the end of a row, put the Wheels/Tines/PTO Drive Lever in "NEUTRAL" and reduce the engine throttle speed.

2. Put the Tines/PTO Clutch Lever in "DISENGAGE".

3. Resume forward operation and lift the handlebars until the tines are out of the ground. Then, using the wheels as a pivot point to balance the engine and tines, PUSH the handlebars to swing the tiller around. *At all times, be careful to keep your feet and legs away from the tines (which should be disengaged).* Let the powered wheels do the work . . . the inside wheel will pivot in place while the outside wheel drives the machine around. See Photos 3-9 and 3-10.

NOTE: Use "REVERSE" if necessary, to turn in a limited space.

4. When the turn is completed, shift into "NEUTRAL" and lower the handlebars. When you are ready to begin a new row, put the Tines/PTO Clutch Lever in the "ENGAGE" position and resume "FORWARD" operation.



3-9: Lift the handlebars and find balance point. Then PUSH handlebars to swing tiller around.

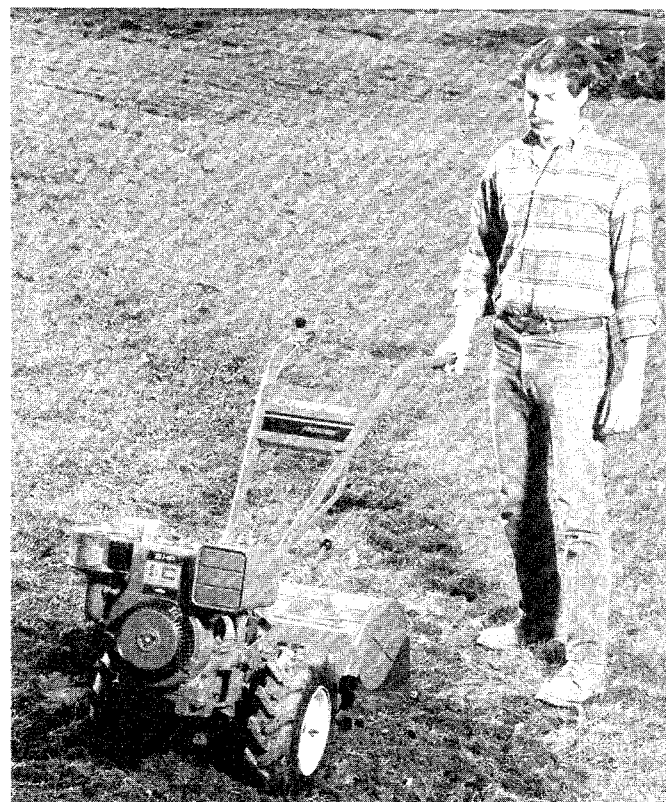

3-10: Starting a new row.

Transporting your tiller

The power driven wheels allow you to easily move your tiller to and from your garden when the engine is running. Or, you can move the tiller (on level ground) without the engine running by using the "FREE WHEEL" position on the Wheel Speed Lever.

WARNING

To help avoid personal injury, always put the Tines/PTO Clutch Lever in the "DISENGAGE" position before transporting, loading or unloading the tiller.

To transport tiller:

1. Place the Tines/PTO Clutch Lever in the "DISENGAGE" position.
2. Move the Depth Regulator Lever all the way down to the "TRAVEL" setting.
3. If using *engine power*, select the "SLOW" or "FAST" wheel speed position on the Wheel Speed Lever and use the Wheels/Tines/PTO

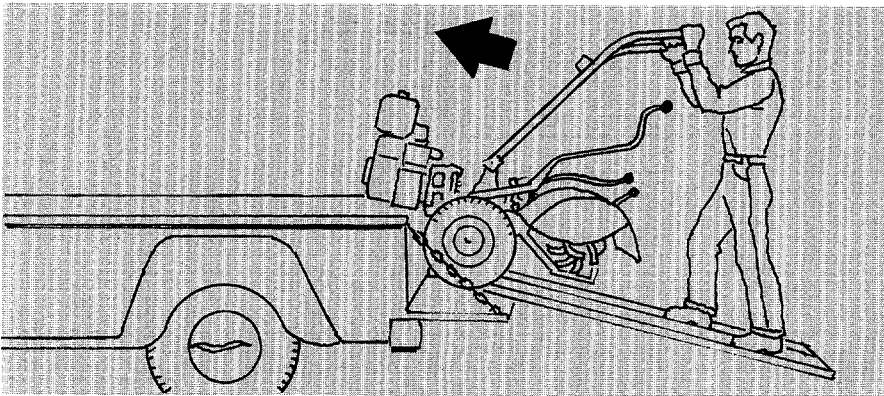

3-11: To go up ramps use "FORWARD" drive.

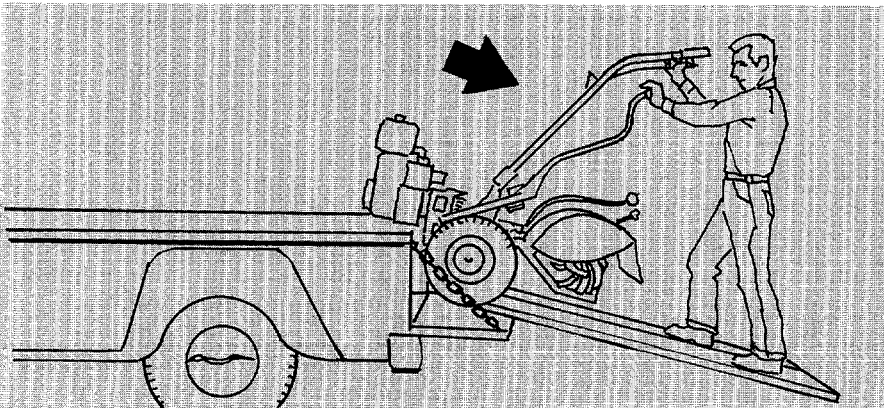

3-12: To go down ramps use "REVERSE" drive.

Drive Lever to drive the wheels.

4. If the *engine is stopped*, put the Wheel Speed Lever in "FREE WHEEL" and manually move the machine.

To load or unload tiller:

1. Use loading ramps that are wide and strong enough to support both the machine and the operator (machine weighs between 280 and 325 pounds).
2. Place the Tines/PTO Clutch Lever in the "DISENGAGE" position.
3. Put the Wheel Speed Lever in the "SLOW" wheel speed position and reduce the engine throttle speed.
4. TO GO UP RAMPS, use "FORWARD" drive and follow the tiller up the ramps (Figure 3-11).
5. TO GO DOWN RAMPS, use "REVERSE" drive and back down the ramps. Never go down the ramps in "FORWARD" drive as the tiller could tip forward, exposing you to the tines (which should be disengaged). See Figure 3-12.

Changing belt speeds

Your Tiller has both "LOW" and "HIGH" speed belt ranges. By moving the belt from one range to the other you can obtain a total of four different forward wheel speeds and two different tine speeds. These extra wheel and tine speeds permit you to tailor your tiller's action to your specific needs in the garden, with less strain on the engine.

Changing from one belt range to the other is simply a matter of moving the belt from one set of grooves on the engine and transmission pulleys to the other set of grooves. See Photo 3-13. This change can be made very quickly in the field and without any tools.

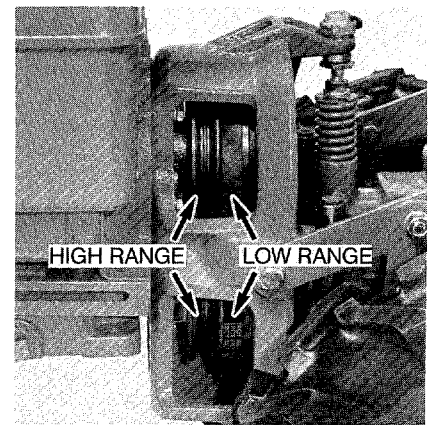

3-13: Belt range positions.

By combining the use of the "LOW" and "HIGH" speed belt ranges with the "SLOW" and "FAST" speed positions on the Wheel Speed Lever, you can obtain four different forward wheel speeds (Figure 3-14). The two different tine speeds (Figure 3-14) are determined by the belt range position alone.

At 3000 RPM (Revolutions Per Minute) engine speed, the wheel and tine speeds are:

BELT POSITION	WHEEL SPEED LEVER POSITION	WHEEL SPEED	TINE SPEED
Low Range	Slow	5 MPH	146 RPM
Low Range	Fast	1.2 MPH	146 RPM
High Range	Slow	7 MPH	200 RPM
High Range	Fast	1.72 MPH	200 RPM

3-14: Wheel and tine speeds.

When the tiller is operating in "REVERSE", the wheels and tines are powered by the rubber reverse disc and not the belt. Therefore, you have only two reverse speeds as determined by the "SLOW" and "FAST" positions of the Wheel Speed Lever.

IMPORTANT

Proper belt tension is critical to good performance. Check the tension after the first 2 hours of new operation and every 10 hours thereafter. See "Drive Belt Maintenance" in Section 6.

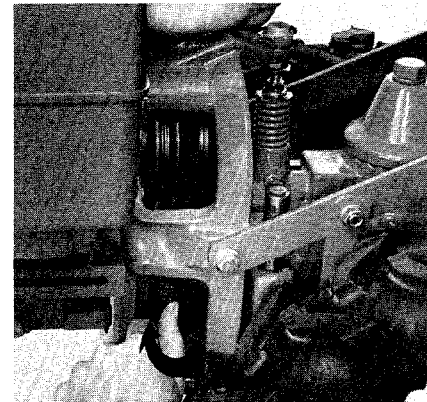

3-15: Move belt on transmission pulley into forward groove.

To change from "LOW" range to "HIGH" range:

! WARNING

To help avoid personal injury, stop the engine, remove the electric start key, disconnect the spark plug wire, and let the engine and muffler cool before changing belt speeds.

1. Place the Wheels/Tines/PTO Drive Lever in "NEUTRAL".
2. While kneeling on the left side of the tiller, create slack in the belt by reaching over to the right side of the pulleys and pushing in on the center of the belt with your finger. Then use your left hand to work the belt part way into the forward groove of the transmission

(lower) pulley. See Photo 3-15. Now go to the other side of the tiller and finish seating the belt in the groove.

3. On the left side of the tiller, work the belt part way into the forward groove of the engine (upper) pulley. See Photo 3-16. Then go to the other side and finish seating the belt. NOTE: If additional clearance is needed to fit the belt over the engine pulley, simply raise the Wheels/Tines/PTO Drive Lever into the "REVERSE" position. This will lower the engine pulley.

4. Check *both sides* of the pulleys to make sure that the belt is fully seated in the "HIGH" range grooves of each pulley.

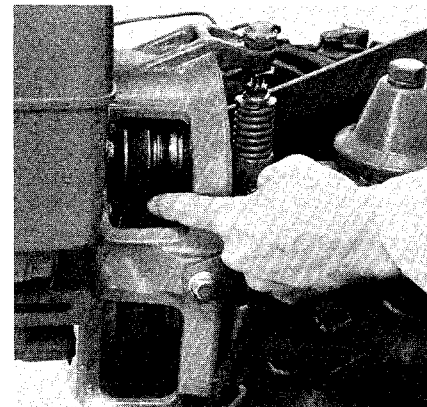

3-16: Move belt on engine pulley into forward groove.

3

To change from "HIGH" range to "LOW" range:

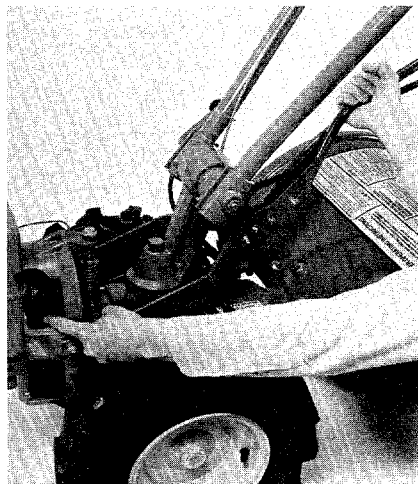

3-17: With drive lever held in "REVERSE", move belt on engine pulley into rear groove.

1. Place the Wheels/Tines/PTO Drive Lever in "NEUTRAL".
2. Stand on the left side of the tiller and use your right hand to hold the Wheels/Tines/PTO Drive Lever up in the "REVERSE" position. Then use your left hand to move the belt part way into the rear groove of the engine (upper) pulley. See Photo 3-17. Now go to the other side of the tiller and finish seating the belt in the groove.
3. While still holding the drive lever in "REVERSE", move the belt into the rear groove of the transmission (lower) pulley. Do this on both sides of the tiller. See Photo 3-18.

4. Check *both sides* of the pulleys to make sure that the belt is fully seated in the "LOW" range groove of each pulley.

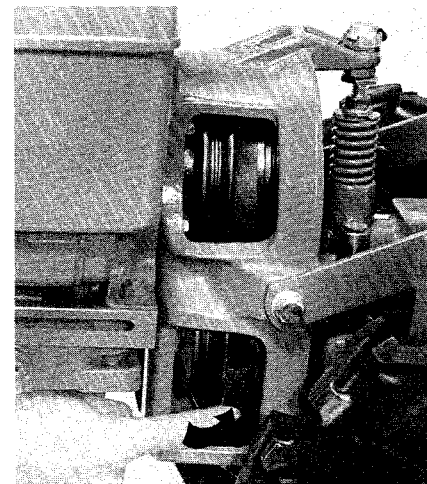

3-18: Move belt on transmission pulley into rear groove.

Choosing wheel and tine speeds

Your tiller offers a wheel and tine speed combination for every tilling task and situation in the garden. With a little experimenting, you can soon find the proper tilling depth, engine throttle setting, and wheel and tine speeds that are just right for the piece of soil you are working on. What this means is:

1. You advance the throttle lever to keep the engine running at a sufficient power level to do the job.
2. You have the depth regulator set in a notch which is not so deep

that it causes the engine to labor or causes the tiller to jump.

3. You have the tines turning over fast enough to really break up the soil with a minimum number of passes. When your tiller is working properly, you can hear that the engine is not laboring very hard and see that the tines are breaking up the soil into small, thoroughly tilled bits. At the proper match of wheel and tine speeds, you will get the job done quickly, and achieve results which are better and more satisfying.

To help guide you in your selections of wheel and tine speeds, please refer to the following chart.

WARNING

The "HIGH" belt range and "FAST" wheel speed combination will propel the tiller at a fast pace. To help avoid personal injury when first using this belt range/wheel speed combination, reduce the engine throttle speed setting to a slower setting.

WHEEL SPEED AND BELT RANGE SELECTION GUIDE

IMPORTANT: For correct wheel speed and belt range choices when using attachments or accessories other than the tines, read the Owner/Operator Manual provided with the attachment or accessory.

SLOW GEAR, LOW RANGE

Till in sod
Till hard clay
Till in cornstalks
Till in cover crops
Prepare very deep seedbed
Till in stony soil
Till in residues and organic matter
Mix in fertilizers and manures

SLOW GEAR, HIGH RANGE

Till in sod
Till hard clay
Till in cornstalks (in most cases, much faster)
Till in cover crops (faster, better job in most soils)
Prepare seedbeds (in most soils better and faster)
Till in stony soils
Make raised beds
Mix in fertilizer
Pull hiller in hard clay soil
Mix fertilizer and manure
Till in residues and organic matter

FAST GEAR, LOW RANGE

Prepare last time over seedbed for planting vegetables and cover crop
Cover seed in wide row or plot planting. (In some soil, handlebars must be held up to keep from going too deep)
Hill and furrow very well
Raise beds easily
Cultivate (In some soil, you may have to hold up on handlebars to avoid going too deep)
Handy in keeping large areas tilled and prepared for a season to improve soil
Till in some organic matter in good soil
Mix in lime
Cultivating between raised beds with hiller/furrower

FAST GEAR, HIGH RANGE

Prepare seedbeds for planting cover crops
Mixing in lime
Cover seeds with less holding up on handlebars (faster than low range)
Cultivate (excellent, saves engine because you don't have to run it wide open, nor hold up handlebars—with rare exception—because it travels faster and stays on top)
Keep large areas tilled and ready through summer (saves a lot of time)
Till in some organic matter.
Moving tiller from one place to another
Cultivating between raised beds with hiller/furrower.

SECTION 4: Tilling in the Garden

In this Section you will find tips and suggestions to help you get the greatest possible satisfaction from your new tiller.

Tilling depths

When you start to till in the garden, remember to take it easy. Do not try to take too deep a cut on the first pass through sod or hard ground that has not been tilled for several months or years. It is almost impossible to dig down four or five inches on the first pass through untilled soil. So, you should start tilling at a *very shallow* depth regulator setting, perhaps only an inch or two deep the first time.

In each succeeding pass, you can go down a few more inches, gradually working down to the depth you want (watering your garden a few days prior to tilling will make the going much easier). At any time, if you have difficulty getting down really deep, let the newly worked soil set for a day or two. When you return to it, the tilling will be easier.

It is best not to work the soil when it is too wet. Doing so will produce large soil clumps that will later dry out and become hard. Test the soil by squeezing it in your hand. If it compresses easily into a ball, it is too wet to till. If time will permit, always wait for the ground to dry before tilling.



4-1: Use shallow depth regulator settings when first starting out.

WARNING

To help avoid personal injury, be aware that the tiller may unexpectedly bounce upward or jump forward and be propelled away from you if the tines should strike extremely hardpacked soil, sod, frozen ground, or buried obstacles such as large stones, roots or stumps. If you are in doubt about the tilling conditions, always use the following operating precautions to assist you in maintaining control of the tiller:

- Walk behind and to one side of the tiller, using just one hand on the handlebars. Relax your arm, but use a secure hand grip.
- Use shallower depth regulator settings, working down gradually deeper with each tilling pass.
- Use slower wheel, tine and engine speeds.
- Clear the tilling area of all large stones, roots and other debris.
- Avoid applying downward pressure on the handlebars. If necessary, apply slight upward pressure to prevent the tines from digging too deeply.
- Always avoid contacting hard-packed soil or sod at the end of a row by reducing the engine speed and lifting the handlebars to raise the tines out of the soil.
- **IN AN EMERGENCY**, stop the tines and wheels by placing the Wheels/Tines/PTO Drive Lever in "NEUTRAL". If you cannot reach the lever or have lost control of the tiller, **LET GO** of the handlebars and all controls and do not attempt to restrain the machine. The Forward Interlock Safety System will stop the engine.

Seedbed preparation

In a well-prepared seedbed, the soil should be as loose and finely textured as possible. Ideally, the soil should be tilled a few weeks prior to the planting date. Then, after a few days, it should be tilled again. Finally, till the area one more time on the day you are going to plant. This procedure will not only produce a finely textured, well-

aerated soil, it will also help to prevent many weed seeds from germinating.

When preparing the soil, go over the same path twice in the first row, then overlap one-half the tiller's width on each succeeding pass. See Figure 4-2. After going up and down the rows in one direction, make a second pass at a right angle across your earlier rows (Figure 4-3). Again, overlap each pass to really pulverize the soil. (In very hard ground, it might take three or four passes before you make much headway.)

If your garden is not wide enough to till lengthwise and then crosswise, then you should first overlap each pass by one-half a tiller width, followed by successive passes of one-quarter width. This overlapping method will assure you of thoroughly breaking up the soil.

If you have plans to expand your garden for next season, then the best time to bust up sod is in the

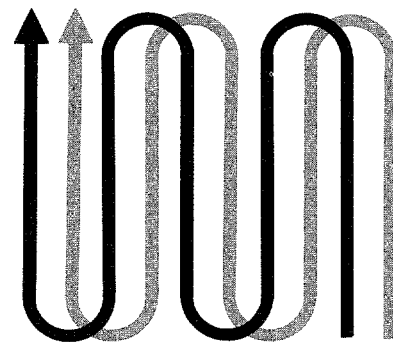

4-2: Use overlapping technique on first pass.

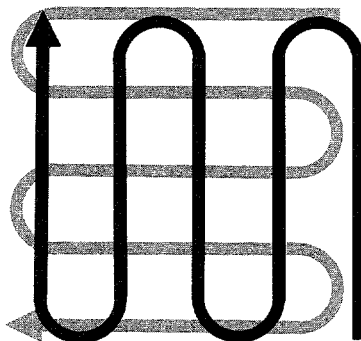

4-3: Make a second pass at a right angle to first pass.

fall. Doing so will allow the sod or tough surface growth to be completely broken down by the time spring rolls around. (Sod busting can be done even in late fall—as long as the ground isn't frozen.) If there is some growing season left, then you should plant a cover crop (see "Power Composting" in this Section), which will help protect the soil over the winter.

Avoid making footprints

When making final tilling or cultivating passes through the garden, always try to walk on the side that is not yet finished. This will avoid leaving footprints in the freshly tilled soil. See Photo 4-4.

Eliminating footprints contributes much more than just good appearance to your garden. It aids in preventing soil erosion and avoids "planting" unwanted weed seeds right back in your newly tilled ground. It also leaves your soil nice and loose, so that vegetable and flower roots can penetrate it easily.



4-4: Try to avoid leaving footprints.

Cultivating

If you plan carefully before planting, you can leave enough room between the plant rows for later cultivating with the tiller . . . all but eliminating most hand-weeding and hoeing chores.

The tiller hood measures 22½" across, so leave that much distance between the rows, plus enough extra for plant growing

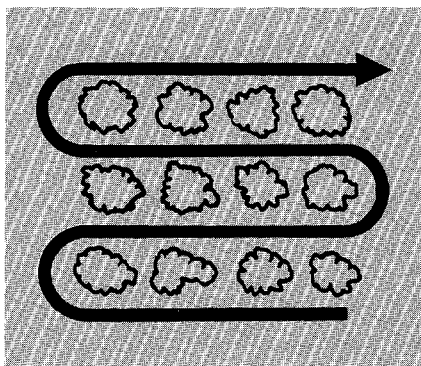

4-5: Leave room between rows for cultivating.

room (especially for bushy crops such as beans, tomatoes and peas). See Figure 4-5.

Cultivating can begin as soon as your seedlings appear above the ground; then cultivate as often as once a week. The day following a rain shower is an excellent time to cultivate, as long as the plants are dry. You should avoid working in the garden when the plants are wet since diseases, blights and rusts can easily be spread among the wet plants with your hands, clothes, or even the tiller.

Shallow cultivation is very important! Do not till deeper than one or two inches, to avoid injuring the roots of nearby plants. If you notice that the tines are digging too deeply even though the Depth Regulator Lever is in one of the top notches, then you may have to lift up on the handlebars slightly (running your tiller in the "HIGH" belt range will help to prevent the tines from going too deep).

Power composting

It is essential that a garden be fed something if it is to be bountiful year after year in the same location. You must replenish the plant nutrients—primarily nitrogen, phosphorous and potassium—that you remove from the soil in the form of harvested vegetables and fruits.

A simple and very effective way to do this is to use your tiller to chop, blend, and turn under all kinds of organic matter including crop residues, leaves, grass clippings and "green manure" cover

SOIL ENRICHMENT IDEA

MULCH—If you use an organic mulch during the growing season, it can be tilled under with your crop residues at the end of the growing season. Popular mulches include hay, old straw, grass clippings, and other dense organic materials. Till this matter under to a depth of 4 to 6 inches.

crops (clover, annual rye, grains, alfalfa, buckwheat, etc.). This organic matter will decompose during the non-growing season and add important nutrients to the soil. See Photo 4-6.

When power composting, set the depth regulator at the deepest setting possible, without making the engine labor too hard or causing the tiller to jump. Crop residues should be tilled into the soil as soon as possible after harvesting, since tender, moist green matter is tilled more easily. We recommend that you use the "HIGH" belt range and "SLOW" wheel speed gear when power composting. If you find the tines aren't working effectively in the "HIGH" belt range setting, then try tilling in the "LOW" range.

After all power composting has been completed, you should plant a cover crop to protect your soil during the non-growing season. Then in the spring, the cover crop can be tilled under a few weeks prior to planting, providing more organic matter to help feed the soil.



4-6: After harvest, till under crop residues to add nutrients to the soil.

SPECIAL TROY-BILT GARDENING TECHNIQUE

How to till under standing cornstalks

As soon as your corn has been harvested, the stalks should be turned into the soil while they are still green. Don't wait until the stalks are dried out, they are tougher to handle and the roots pull out more easily. **YOU DON'T WANT TO PULL THE ROOTS OUT BY HAND, OR CUT THE STALKS, BEFORE TILLING.** It is the action of the stalk (held in place by its root structure), being chopped against the soil that makes it so easy for your tiller to cut it down and chop it up, partially burying much of the cornstalk material in the first pass.

Knocking down cornstalks and

tilling them under is not difficult once you understand three basic principles. First, the stalks should go in between the left wheel and the transmission case, as shown in Photo 2. (The right wheel will not work because the stalks might interfere with the carburetor, air cleaner, or throttle linkage.)

Second, each pass should overlap one-half a tiller width over the ground tilled on the previous pass. And third, till just as deeply as you did when preparing the ground for planting. This usually means that the depth regulator is pulled all the way UP to the deepest setting possible, depending upon the condition of the soil. Generally, the "LOW"

or "HIGH" belt range and "SLOW" wheel speed gear will be best for tilling under cornstalks. However, some folks will even be able to use the "LOW" belt range and "FAST" wheel speed gear, depending upon the size of the stalks and the condition of the soil.

Allow the tilled-in cornstalks to lay in the ground undisturbed for a week to give the active soil life a chance to start decomposition and digestion of the stalks. Then, till in the residue as deeply as possible. This will probably take only one overlapping pass through the garden. Four or five days after this final tilling, you can sow a cover crop, such as annual rye grass.



(1) Make first pass alongside first row with **RIGHT** wheel up close to, but not touching any cornstalk. The purpose of this pass is to loosen up soil in preparation for next pass.

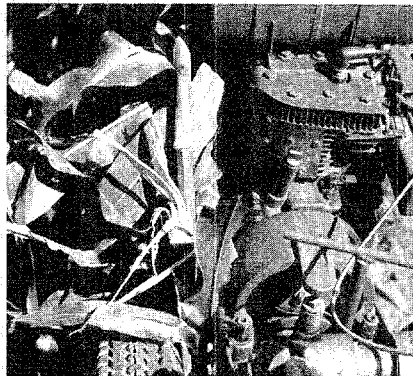

(2) Make second pass with stalks in between **LEFT** wheel and transmission case (overlap first pass by one-half tiller width). This pass will knock down stalks and cut some into one or two-foot lengths, partially burying them.



(3) On third pass, go back over stalks that are lying down, but this time from opposite direction. This will bury much of the residue 3 or 4 inches under the soil.



(4) The fourth pass will be back down between rows, overlapping one-half the No. 3 pass.



(5) Make fifth pass alongside next row of cornstalks, with right wheel up close to, but not touching stalks.



(6) The sixth pass will start to knock down the next row of stalks. Repeat previous steps until all rows are down and buried.

Clearing the tines of debris

Your Bolo Tines feature a self-cleaning action which eliminates most tangling in the tines. But occasionally, dried out grass, stringy stalks, or tough vines may become tangled. It isn't necessary to remove all the residue, but don't let it build up to a point where it chokes off the action of the tines.

You can avoid most tangling problems by setting the depth regulator deep enough to get maxi-

mum chopping action as the tines chop the material against the ground, and by tilling under crop residues or cover crops while they are still green, moist and tender. Also, you might try swaying the handlebars laterally from side to side about 6 to 12 inches while continuing to power compost. This "fishtailing" action will often clear the debris out of the tines.

If the tines become tangled,

STOP the engine and remove the tangled material by hand. A small pocket knife or linoleum knife will help you to cut away the material.

WARNING

To help avoid personal injury, stop the engine, remove the electric start key and disconnect the spark plug wire before attempting to clean the tines by hand.

Tilling up and down slopes

If you must garden on a moderate slope, then the best way to do so is by planting rows up and down the slope. Tilling vertically on a slope permits you to use the entire area for your seedbed, as well as to provide enough room between rows so that you can cultivate between them (you lose these valuable benefits when you terrace garden, which is discussed further on). See Photo 4-7.

Growing a garden vertically on a slope does not involve much of a soil erosion problem, as long as you put in enough organic matter to improve the moisture holding ability of your soil and you do not leave footprints or wheelmarks. Soil in this condition is loose enough to prevent packing, and is held together well enough by those organic materials so that it readily absorbs water.

When tilling vertically on a slope, try to make the first pass in an uphill direction. The tines dig in much more deeply going uphill than when going downhill. In soft soil or weeds, you may have to lift the handlebars up slightly as you go uphill. When going back down the slope, overlap your first pass by about half the width of the tiller. For best results, use the "HIGH" belt range and "SLOW" wheel speed setting while tilling up and down slopes.

CAUTION

TO AVOID PERSONAL INJURY OR DAMAGE TO EQUIPMENT:

- Do not operate the tiller on a slope that is too steep for safe operation. Go slowly and make sure you have good footing.
- Wear footwear that will increase stability and reduce slippage.
- Do not use the "FAST" wheel speed position while on sloping ground.
- Do not shift the Wheel Speed

Lever when heading up or down a slope. If the lever is accidentally placed in "FREE WHEEL", the machine could roll out of control.

- To prevent engine damage due to oil starvation, make sure that the proper oil level is maintained during all uphill tilling operations. Check the oil level after every one-half hour of operation.

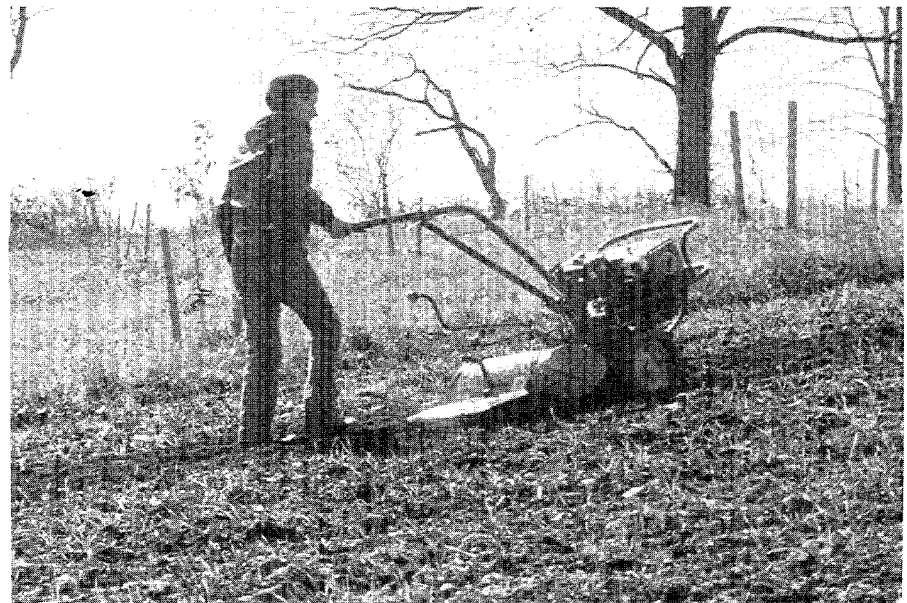

4-7: Tilling on a moderate slope.

Terrace gardening

If a slope is too steep or too short for vertical tilling, it may be necessary to till across the slope in a lateral direction. The best way to achieve good results tilling across a slope is to create terraces for your garden (first, make sure that the slope is not too steep for safe tilling).

Terraces should be about two or three feet wide. This means you will be able to plant one or two rows of plants and later till under the crop residues, but there may not be room enough for cultivating with your tiller. (If you make the terraces too wide, you would be digging as much as a foot into the uphill side of the terrace and you would end up trying to grow plants in poor subsoil).

Using the “LOW” belt range and “SLOW” wheel speed gear, start to terrace on the top of the slope and work down, always keeping the uphill wheel in the soft, newly tilled soil. Each succeeding terrace is started by walking below the terrace you are preparing. In four or five passes, your tiller can carve out a flat and wide enough terrace for planting. See Figure 4-8 and Photo 4-9.

Make sure that you don’t till the last 12-inches or more of the downhill outside edge of each terrace. Keeping this strip untilled will help to prevent the terraces from breaking apart and washing downhill. It also gives you a walking path between the terraces.



4-9: Terraces 2 or 3-feet wide are ideal.

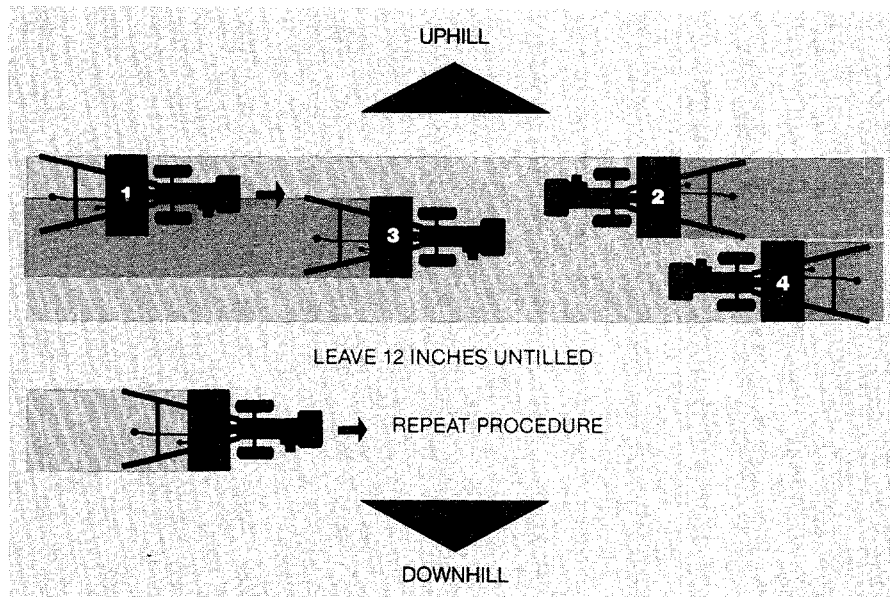

4-8: How to make terraces in 4 or 5 passes.

Tilling across slopes without terraces

Tilling across a slope without forming terraces is not recommended, but it can be done. However, please think it over carefully and see if it isn’t possible to till vertically up and down the slope,

or to create terraces.

First, make sure that the slope is not too steep to till safely at all. Then, begin at the top of the slope and overlap half of each tilled path, always keeping the uphill wheel in

the soft, newly tilled soil. Doing so will help you keep the tiller more stable. For best results, use the “LOW” belt range and “SLOW” wheel speed gear.

SOIL ENRICHMENT IDEA

TRENCH COMPOSTING—Trench composting is easy with the optional Hiller/Furrower attachment (see Section 9). Just dig a trench, put in all manner of organic matter and biodegradable household garbage and cover it up with soil. The earthworms and microbial life in the soil will consume it faster than you might imagine.

SPECIAL TROY-BILT GARDENING TECHNIQUE

How to make raised beds for planting

It's easy to make raised beds with the optional Hiller/ Furrower Attachment. Most crops can't grow in wet soil or heavy clay conditions because they can't get the air or nutrients they need for growth. Raised beds can solve this problem.

In addition, raised beds provide a good irrigation system, discourage soil compaction (from walking near the plants), give your soil earlier and greater exposure to the sun, increase the amount of topsoil around the crops, and provide looser soil conditions for root crops to grow in.

You can even try wide row planting on raised beds. Rows can be anywhere from 30 inches to 3 feet apart, and 8 to 10 inches high.

Easy Steps to Raised Beds:



(1) Till under sod or crop residues and work soil into a deep, smooth, loose seedbed.

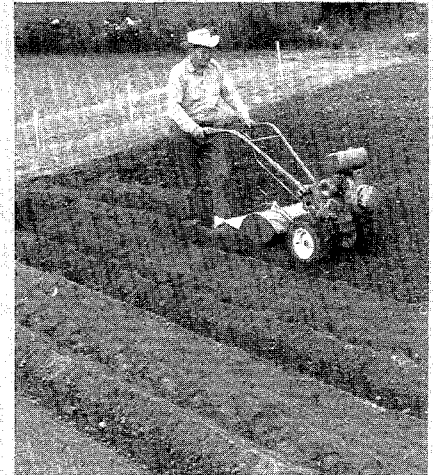

(2) Place row-marker stakes at proper intervals; attach hillier/furrower and make your rows.



(3) Hold the handlebars with both hands and use faster tiller and engine speeds.



(4) After planting seeds in ridges, rake loose soil over top and firm soil according to seed directions.

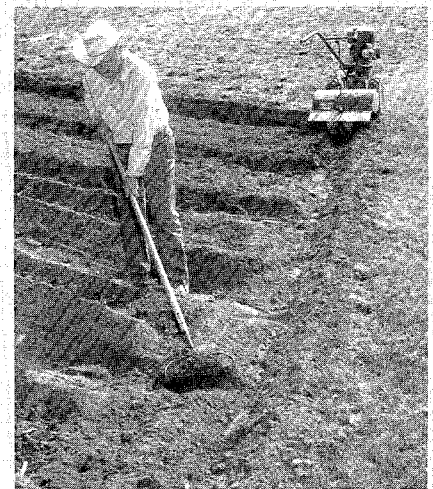

(5) Use furrower to make irrigation trench at ends of rows.

SOIL ENRICHMENT IDEA

LEAVES—Leaves are an excellent (and free) natural fertilizer that will do wonders for your soil's fertility and texture. In the fall, spread 6 to 8 inches of leaves on the ground and till them under. If enough growing season is left, you can till once again after a few days, and then sow a cover crop.

SOIL ENRICHMENT IDEA

SHEET COMPOSTING—All manner of organic material including weed-free manure and mulches, leaves, straw, hay and grass clippings can be "sheet composted" directly into the soil. Just spread the material around and till it under—it's a lot quicker than the lengthy compost-pile process.

SPECIAL TROY-BILT GARDENING TECHNIQUE

Try wide-row planting

Wide-row planting is a highly productive gardening technique that is worth trying. As the name implies, it involves broadcasting seed in bands anywhere from 10 inches to 2 or more feet wide, rather than in traditional single-file rows.

The greatest advantage to this gardening method is that you have more plants per area in your garden, which results in much higher yields from the same amount of space (see Photo 4-10). Typically, you can grow anywhere from 3 to 4 (or more) times produce in the same space normally set aside for a single row.

In addition, when you plant crops in wide rows, you automatically

shade the ground. Shading prevents most weeds from growing and also holds moisture in the ground. Wide rows also protect the soil from temperature fluctuations and makes harvesting easy, since you can sit and pick so much produce from one spot.

It's simple to plant and grow wide-row crops. First prepare a loose, smooth, fertile seedbed and mark off your row with strings—Photo 4-11. Hand broadcast the seeds over the raked area as if you were seeding a lawn (remember to plant vegetable seeds a little thinner than grass seed). Cover them with soil from outside the row, tamping it down firmly with a hoe. If you're planting larger seeds such

as peas or lima beans in wide rows, you can run your tiller over them, planting about 2 or 3 inches deep. If you use your tiller for planting, sow your seeds a little thicker as some of them won't get deep enough to germinate. After tilling, firm the soil.

Plant the larger-seeded crops, such as beans or peas, with a little care so you won't have to thin later on. For small-seeded crops, such as lettuce and carrots, you can easily thin as soon as they come up by lightly dragging a steel garden rake across the row about ¼-inch deep. You will also disturb and kill many tiny weed seeds that have begun to sprout near the soil surface.



4-10: Wide-row planting on the right compared to single row on the left.



4-11: After preparing seedbed, mark off row area as wide as you want, even up to 4-feet across.



4-12: Wide-row planting really works, as evidenced by this lush growth of peas.

HERE'S ANOTHER SPACE SAVING METHOD: Planting in double (or even triple) rows is another space saving idea that many Troy-Bilt Tiller owners use. Beans, for example, can be planted in two rows spaced 6 to 8 inches apart. On either side of the double row, leave enough room for sidegrowth and later cultivating with your tiller. It is still necessary to thin seedlings according to the seed company's directions on the packet.

SECTION 5: The PTO Power Unit

As explained on Page 2 of this Manual, your tiller can be converted into a self-contained PTO Power Unit that is capable of powering or towing other attachments besides the tine attachment that came with your tiller. The instructions given here will help you become familiar with your PTO Power Unit. Please read this Section thoroughly.

VERY IMPORTANT

Before trying to operate your PTO Power Unit for the first time, make sure that you have:

- Read and understand all of the Safety Instructions in Section 1 of this Manual and in the Owner/Operator Manual that is supplied with any attachment.
- Read and understand all of the controls information and operating procedures for the tiller and engine as described in Sections 2 and 3 of this Manual.
- Read and understand all of the assembly instructions, controls information, and operating procedures for the attachment as described in the Owner/Operator Manual that is supplied with the attachment.

Removing and replacing the tine attachment

The following steps explain how to remove and replace the tine attachment. The only tool you'll need is a 3/4-inch wrench (at least 12-inches long for adequate leverage).

There are two optional accessories available that make the following steps easier. One is the

Kickstand Attachment which prevents the PTO Power Unit (engine end) from falling forward when attachments are removed (Photo 5-2). The other is the Tine Attachment Cradle which provides a handy support for the tine attachment when it is removed from the tiller (Photo 5-3). For more information about these two accessories, please refer to Section 9 of this Manual.



CAUTION

TO AVOID PERSONAL INJURY OR DAMAGE TO EQUIPMENT:

- Stop the engine, remove the electric start key, disconnect the spark plug wire and let the engine and muffler cool before removing or installing any attachment.
- Do not place hands, tools, or any object near or inside the PTO access hole when the engine is running.
- When removing and replacing the tine attachment, be careful not to cut yourself on the edges of the tiller hood. Wear thick gloves for maximum protection.
- When the tine attachment is removed, always place the optional tine cradle or a wood block or other sturdy support beneath its coupling point to prevent the attachment from falling forward.

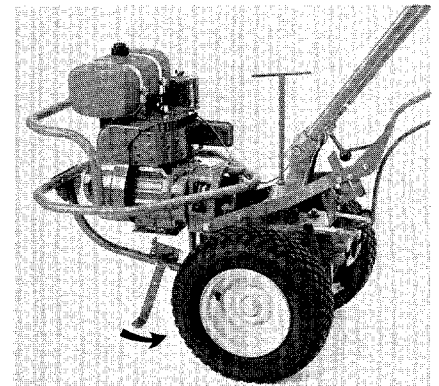

5-2: Kickstand prevents engine from tipping forward.

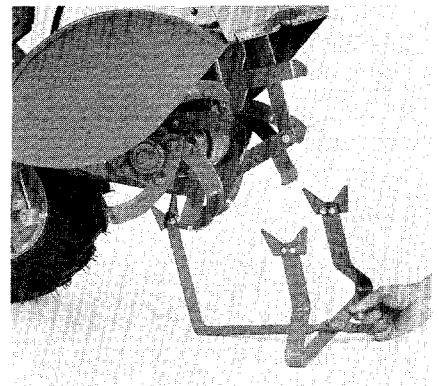

5-3: Tine Attachment Cradle.

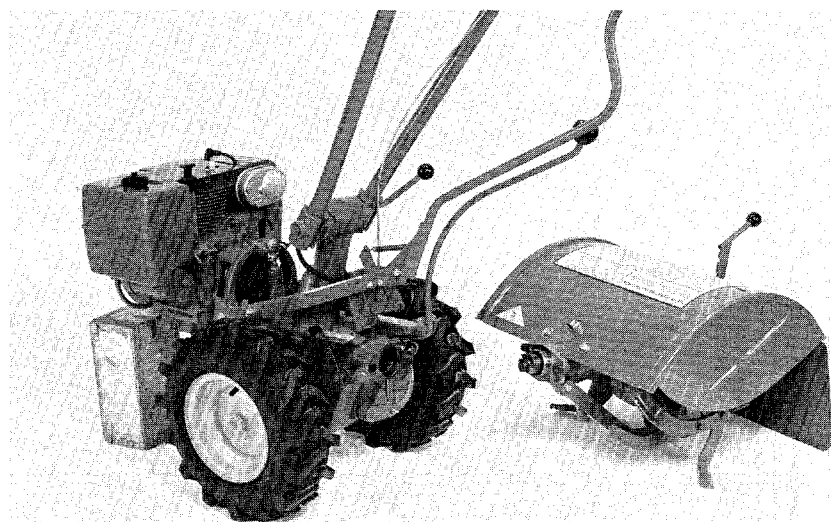

5-1: PTO Power Unit with tine attachment removed.

To remove the tine attachment:

1. Make sure that the engine is stopped, the electric start key is removed, and the spark plug wire is disconnected.
2. The equipment must be on level ground.
3. Place the Wheels/Tines/PTO Drive Lever in "NEUTRAL" (Photo 5-4).

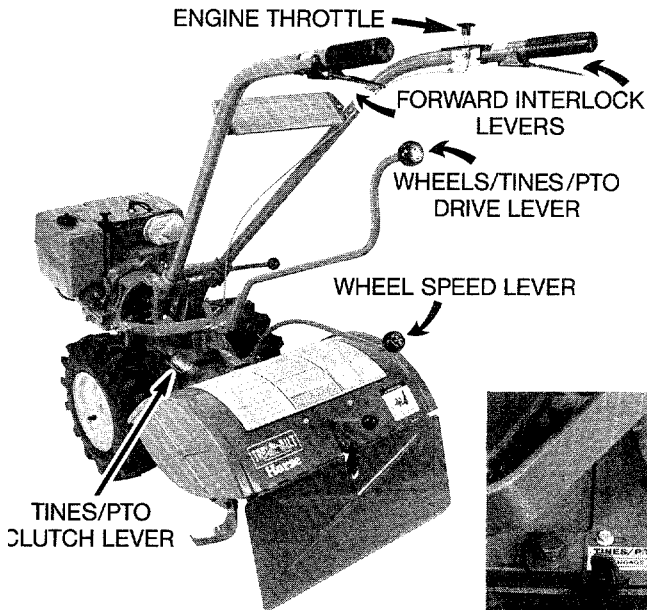

5-4: PTO Power Unit controls.

4. Place the Tines/PTO Clutch Lever in "DISENGAGE" (Photo 5-4).
5. Place the Wheel Speed Lever in "FREE WHEEL" (Photo 5-4).
6. Place a sturdy support under the engine, or use the Kickstand on your bumper (if so equipped) to prevent the engine from tipping down when the tine attachment is removed. See Photo 5-5.
7. Using a 3/4-inch wrench, loosen the two swing-bolts that connect the power unit transmission to the tine attachment and swing the bolts outward. See Photo 5-6. NOTE: An extra-long (13") PTO Wrench is available from our Parts Department. This heavy-duty wrench (Part No. 2005) makes it quick and easy to remove and replace the tine attachment.

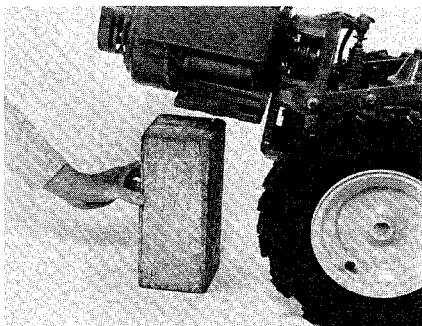

5-5: Block up engine.

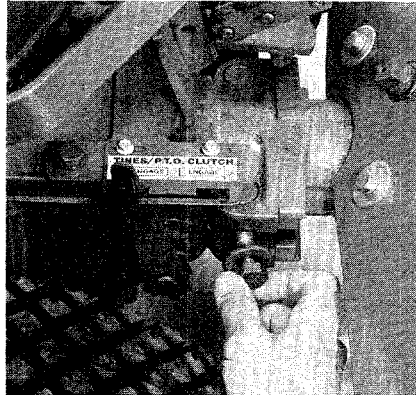

5-6: Move swing-bolts outward.

8. With one hand on the handlebars of the power unit, tip the unit forward about an inch while you pull the tine attachment back a short distance. This releases the guide pin on the power unit from the guide pin mounting hole in the tine attachment. See Photos 5-7 and 5-8.

IMPORTANT

Always store your tine attachment in a level position to avoid losing oil from the breather vent, located in the top of the dipstick.

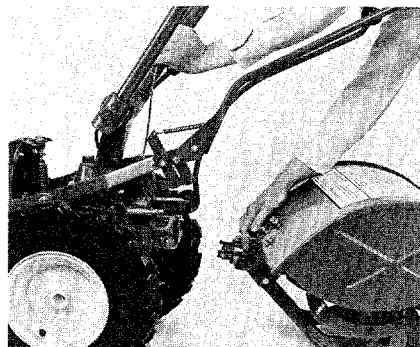

5-7: Lift handlebars while pulling attachment away from power unit.

9. Place the dust cap (supplied with certain attachments), or some plastic wrapping over the "dog" clutch coupling of the tine attachment to prevent dirt and grime from accumulating on the coupling.
10. The power unit is now ready to accept other powered or non-powered attachments. Refer to the Owner/Operator Manual supplied with each attachment for specific instructions on how to install and operate the attachment.

To replace the tine attachment:

1. Follow Steps 1-5 of the previous tine attachment removal instructions.
2. Place the two swing-bolts on the power unit in the outward position, making sure that the washers on the bolts are next to the bolt heads.
3. Roll the power unit back to the tine attachment and either put down the optional Kickstand or place a sturdy support under the engine.
4. Remove the dust cap or protective wrapping from the clutch coupling on the tine attachment.
5. Carefully align the alignment pin on the power unit with the alignment hole on the tine attachment and bring the two units together (Photo 5-8).

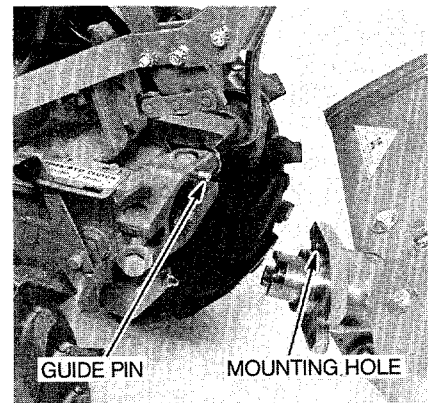

5-8: Align guide pin with mounting hole.

PTO Power Unit operating instructions

6. Place the two swing-bolts in the slots of the tine attachment. Alternating between the two bolts, tighten each securely until the concave washers on the bolts are flat. The bolts must be very tight. If using a torque wrench, tighten each to 70-80 ft. lbs. See Photo 5-9.

IMPORTANT

The swing-bolts must be kept very tight at all times to prevent undue wear on the "dog" clutch couplings, or on the alignment pin and hole. Check bolts for tightness after every 2-½ hours of operation.

7. Remove the engine support before attempting to drive the unit in a forward direction.



5-9: Tighten both swing-bolts.

WARNING

To help avoid personal injury or damage to equipment, read the Owner/Operator Manual provided with each attachment before attempting to install or operate the attachment. The Manual provides a detailed description of proper use and operation, and points out other important Safety Instructions.

The following instructions describe how to operate the PTO Power Unit ONLY. Read the separate Owner/Operator Manual for each attachment carefully before attempting to assemble, attach, transport or operate the attachment. If you do not have a Manual, call or write us for a replacement copy (be sure to supply us with the serial number of your attachment).

Some attachments have a drive shaft or a hydraulic pump that is powered by the engine on the PTO Power Unit. These attachments are called "Stationary Attachments", because they must remain in a stationary position when being operated (they can be towed to the work site by the power unit, as described in "To Operate Non-Powered Attachments").

Other attachments are simply

pulled or towed behind the PTO Power Unit. These attachments are called "Non-Powered Attachments".

WARNING

To help avoid personal injury, always disengage the Tines/PTO Clutch Lever before towing any attachment.

Before starting engine:

IMPORTANT

Before operating in temperatures below 40°F, refer to the "Cold Weather Operation" instructions in Section 3 of this Manual.

1. Put the Wheels/Tines/PTO Drive Lever in "NEUTRAL". To find "NEUTRAL" (while engine is not running), push the lever down until it engages in "FORWARD". Then tap or lift the lever up and release it. (Photo 5-4).
2. Put the Tines/PTO Clutch in "DISENGAGE".
3. FOR STATIONARY ATTACHMENTS ONLY:
 - (a) Put the Wheel Speed Lever in "FREE WHEEL" and block ALL wheels to prevent rolling of equipment. (See Photo 5-4 and Figure 5-10).

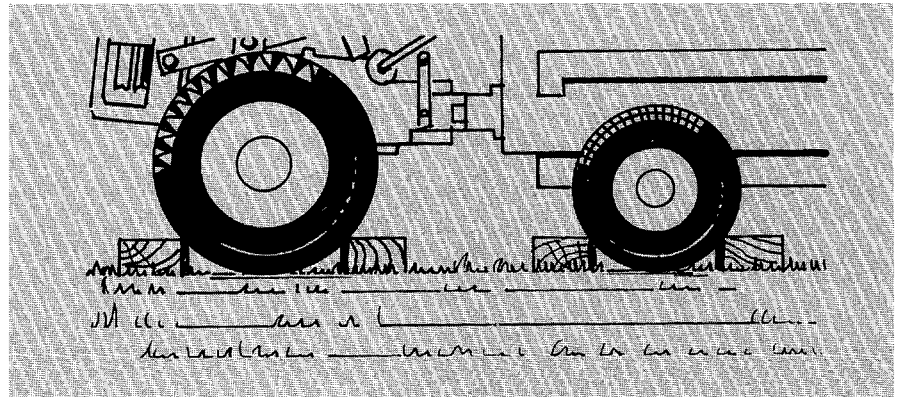

5-10: Block wheels on power unit and stationary attachment.

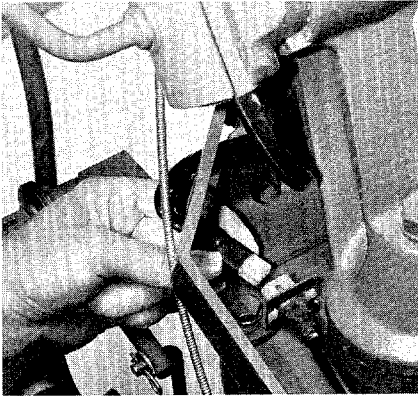

5-11: Disconnect the Forward Interlock Wire Harness.

- (b) On the Power Unit, unplug the Forward Interlock Wire Harness that leads from the bottom of the handlebars to the receptacle located on the top, right side of the transmission cover. See Photo 5-11).
 - (c) On the Stationary Attachment, locate the interlock wire and make sure that the surface of the plug is clean.
 - (d) Connect the plug from the Stationary Attachment to the receptacle on the Power Unit. See Photo 5-12. Make sure that the connection is tight. This connection allows you to operate the Wheels/Tines/PTO Drive Lever in "FORWARD" without having to simultaneously squeeze and hold one of the Forward Interlock Levers.
- 4. FOR NON-POWERED ATTACHMENTS ONLY:**
- (a) Put the Wheel Speed Lever in either "SLOW" or "FAST" (roll power unit while shifting until wheels are engaged). See Photo 5-4.
 - (b) Make certain that the Forward Interlock Wire Harness plug at the bottom of the power unit handlebars is connected to the Forward Interlock Wire Harness receptacle on the top, right side of the transmission (Photo 5-13).

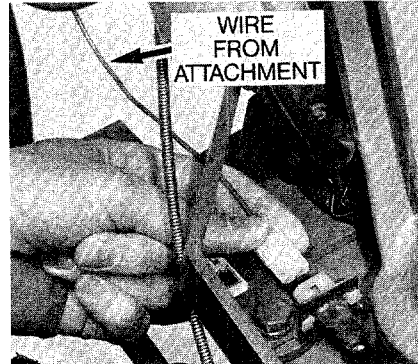

5-12: Connect wire from Stationary Attachment to receptacle on Power Unit.

- 5. Move the Engine Throttle Lever away from the "STOP" position and use the Choke Control if the engine is cold. Pull the Recoil Rope or use the Key Switch (on Electric Start models). When the engine starts, move the Choke Control (if used) to "CHOKE OFF" and let the engine warm up. (See Section 3, "Operation of Tiller" for more detailed engine starting steps.)
- 6. For non-powered attachments only, test Forward Interlock Safety System. See page 17.

! WARNING

To avoid injury, do not run the engine in an enclosed or poorly vented area. Engine exhaust contains carbon monoxide, an odorless and deadly gas.

To operate Stationary Attachments:

- 1. Put the Tines/PTO Clutch in "ENGAGE".
- 2. To apply power to PTO driven attachments, move the Wheels/Tines/PTO Drive Lever down to "FORWARD" (do not use "REVERSE" with Stationary Attachments).
- 3. TO STOP PTO POWER: Tap or lift the Wheels/Tines/PTO Drive Lever up to "NEUTRAL".



5-13: Forward Interlock Wire Harness.

To Operate Non-Powered Attachments (or to tow Stationary Attachments):

- 1. To go forward, squeeze and hold one Forward Interlock Lever (Photo 5-4) and then move the Wheels/Tines/PTO Drive Lever down to "FORWARD".
- 2. TO STOP FORWARD MOTION: Tap or lift the Wheels/Tines/PTO Drive Lever up to "NEUTRAL" and then release BOTH Forward Interlock Levers.
- 3. TO STOP FORWARD MOTION IN AN EMERGENCY: Let go of ALL power unit controls (this will stop the engine).
- 4. For reverse motion, first reduce the engine speed and put the Wheel Speed Lever in "SLOW". Then hold the Wheels/Tines/PTO Drive Lever up. (Make sure the area behind you is clear before reversing.)
- 5. TO STOP REVERSE MOTION: Release the Wheels/Tines/PTO Drive Lever.

To stop engine:

Move the Engine Throttle Lever to "STOP" (and turn Key to "OFF" on Electric Start models).

SECTION 6: Maintenance and Service

Your tiller and its engine require regular care and maintenance if they are to give you the many years of service that you should expect of them.

Most maintenance and repair procedures are easy to do yourself with the help of the step-by-step

instructions found in this Section. Of course, you can always call or write the factory for expert advice, or you can obtain factory authorized service at one of our regional stores, or from a nearby TROY-BILT Tiller authorized dealer.

IMPORTANT

All references to "left" and "right" sides of the tiller are given from the operator's position behind the handlebars.

RECOMMENDED MAINTENANCE INTERVALS

PROCEDURE	EVERY USE	EVERY 10 HOURS	EVERY 25 HOURS	EVERY 30 HOURS	EVERY 50 HOURS	EVERY 100 HOURS	AS NOTED
Check engine oil level	•						After every 5 operating hours
Clean engine cooling system	•						
Test operation of Forward Interlock Safety System	•						See Page 17 for test procedure
Check Forward Interlock Safety System wires for loose connections, fraying, or bare spots		•					
Check battery electrolyte level and electrical connections		•					
Recharge battery							Before and after prolonged storage
Check drive belt tension		•					After first 2 break-in hours
Check nuts and bolts		•					After first 2 break-in hours
Clean tiller tine shaft		•					
Lubricate tiller		•					
Change engine oil*		•					More frequently in extremely dusty or dirty conditions
Clean foam element air filter			•				More frequently in extremely dusty or dirty conditions
Check paper element air filter			•				
Check for oil leaks			•				After first 2 break-in hours
Check gear oil level in Power Unit and Tine Attachment transmissions				•			After first 2 break-in hours
Check Bolo Tines for wear				•			
Check reverse disc for wear				•			
Check air pressure in tires				•			
Check spark plug					•		
Replace paper element air filter						•	More frequently in extremely dusty or dirty conditions

*During new engine break-in period, change engine oil after first 5 hours of operation.

Tighten bolts and nuts

WARNING

To help avoid personal injury, stop the engine, remove the electric start key, disconnect the spark plug wire, and let the engine and muffler cool before inspecting or servicing the tiller or engine.

It's a good idea to check for loose or missing bolts, nuts and screws after every 10 operating hours. Failure to tighten or replace fasteners can result in poor performance, equipment damage, or oil leaks. If you need to replace a fastener, be sure to refer to your Parts Catalog for the correct size and for any special grade specification. Most fasteners are available locally, or you can order directly from our Parts Department.

Most bolts, nuts and screws on your tiller are easily visible. Please refer to Photos 6-1, 6-1A and 6-2 for the following fasteners that require special attention.

1. Check transmission pulley mounting bolt (Photo 6-1). If washer behind bolt head is loose,

then bolt must be tightened securely. To tighten bolt, insert a punch or thick screwdriver into the hole next to the bolt and wedge the tool against the side of the motor mount casting. This will prevent the pulley from turning as you tighten the bolt.

2. Check jam nut on left side of neutral plunger assembly (Photo 6-1A). If loose, place one wrench on head of bolt and tighten jam nut with second wrench.

3. Check the three rear bearing cap screws that are located underneath the depth regulator mounting bracket assembly ("A" in Photo 6-2). If these screws are loose it could cause an oil leak or excessive end play in the drive shaft.

4. Check the five bolts that fasten the tiller housing cover to the left side of the transmission ("B" in Photo 6-2). If the bolts or cover are loose, it could cause an oil leak. To gain access to the housing cover, you will have to remove the left side tine holder. See "Bolo Tine Maintenance" in this Section for tine holder removal instructions.

5. Check the two swing-bolts that connect the power unit transmission to the tine attachment ("C" in Photo 6-2). These bolts should be checked after every 2-½ hours of operation. Failure to do so could cause excessive wear to the locating pin on the power unit, and enlargement of the locating hole in the tine attachment. The bolts must be kept very tight. If you have a torque wrench, tighten each to 70-80 ft. lbs.

6. Check the locknut that fastens the shifting linkage to the eccentric shifting lever ("D" in Photo 6-2). Do not tighten the locknut against the eccentric lever. It should be very close to, but not touching the lever.

IMPORTANT

Screws or bolts that thread into the transmission housing should be coated with a non-hardening gasket sealant (available at hardware or automotive supply stores). The sealant helps to prevent oil from leaking past the threads.

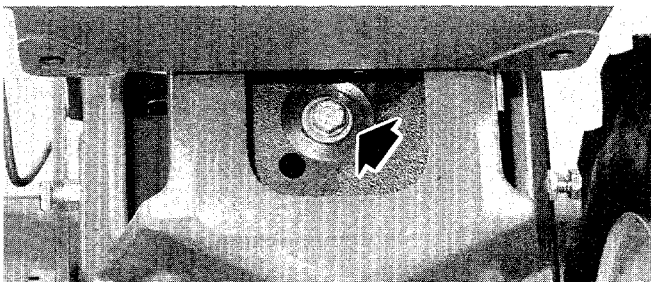

6-1: Check bolt on transmission pulley.

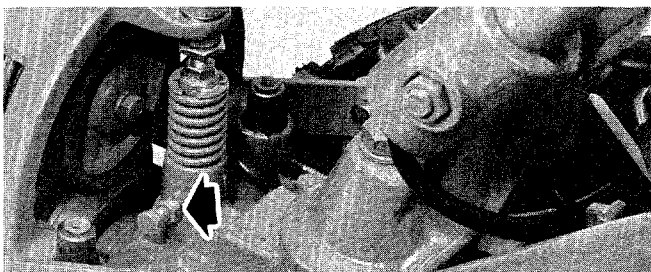

6-1A: Check jam nut on plunger assembly.

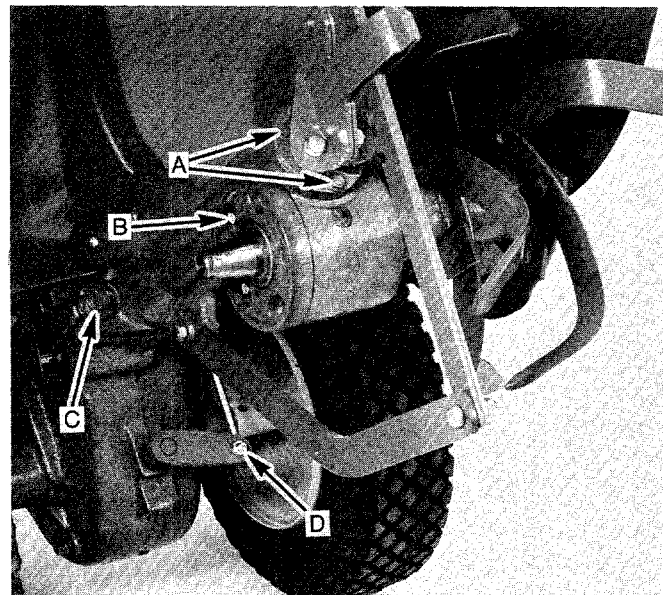

6-2: Gently tilt tiller forward to check these fasteners.

Tiller lubrication

WARNING

To help avoid personal injury, stop the engine, remove the electric start key, disconnect the spark plug wire, and let the engine and muffler cool before inspecting or lubricating the tiller.

Proper lubrication of the tiller's mechanical parts is an essential part of your maintenance program. Lubrication should be done after every 10 hours of operation.

Use ordinary motor oil (#30 weight, or lighter) where oil is called for. Use a good quality grease that contains a metal lubricant; however, regular grease is acceptable. Do not over lubricate! Excess lubricant merely collects dirt which can cause wear to moving parts. If you notice a build up of dirt, clean the area and reapply fresh oil or grease.

IMPORTANT

Do not permit oil or grease to come in contact with the pulleys, the drive belt, or the reverse disc. Doing so will cause the belt or disc to slip on the pulleys.

The following numbers refer to the numbered lubrication points shown in Photos 6-3 and 6-4.

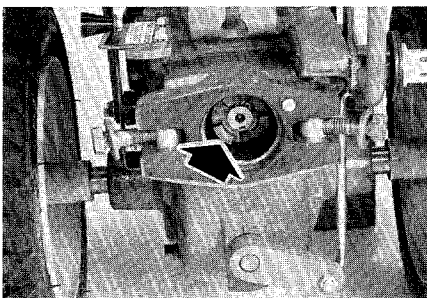

6-3: Use plenty of grease in PTO access hole.

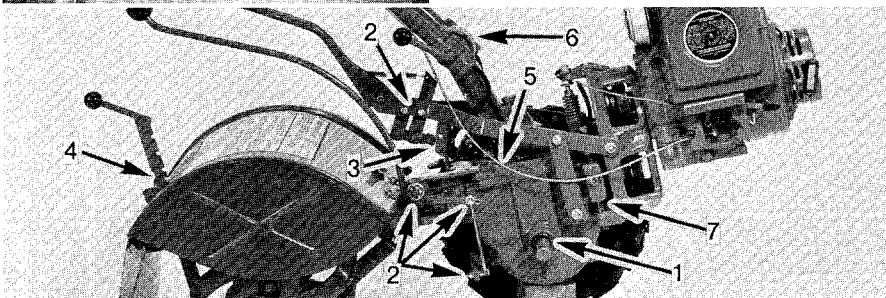

6-4: Tiller lubrication points (wheel removed for photo clarity only).

1. Oil the wheel shaft between the wheel hubs and the transmission housing (Photo 6-4).
2. Oil all of the pivoting and connecting points on the Wheels/Tines/PTO Drive Lever and the Wheel Speed Lever (Photo 6-4). If Wheel Speed Lever has a grease fitting on pivot assembly, apply 2-3 strokes of multi-purpose grease at beginning and end of tilling season.
3. Grease the face of the belt adjustment block (Photo 6-4).
4. Oil the back and sides of the Depth Regulator Lever, including the spring in the mounting bracket (Photo 6-4).
5. Oil the entire length of the throttle cable casing, starting up at the Engine Throttle Lever and going all the way down to the engine (Photo 6-4).
6. Oil the threads on the Handlebar Height Adjustment Lever (Photo 6-4).
7. Grease the left and right side engine mounting bars at the top, in the middle, and at the bottom (Photo 6-4).
8. Maintain a good supply of grease inside the PTO (Power Take-Off) access hole (Photo 6-3). If the Tines/PTO Clutch Lever is hard to shift, squirt some oil into the access hole and move the lever back and forth, trying to work the oil in between the PTO coupling and the sides of the housing. Call our Technical Service Department if the problem persists.

Transmission gear oil maintenance

WARNING

To help avoid personal injury, stop the engine, remove the electric start key, disconnect the spark plug wire, and let the engine and muffler cool before inspecting or servicing the tiller.

A. Checking for oil leaks

At every 25 hours of operation you should check your tiller for oil leaks. Look for accumulations of dirty oil on the tiller or on the floor where you've parked the tiller.

A little seepage or wetness around a shaft opening or cover is nothing to be alarmed about. However, if there is a heavy accumulation of oil, or if oil drips while sitting overnight, then you should replace the worn seal or gasket right away (first try tightening any loose screws or bolts).

If you're not sure how much oil has been lost, then be sure to check the oil level before operating the tiller again. Operating the tiller when the power unit or tine attachment transmission oil levels are low can result in serious damage to the transmissions.

When tilling during very hot weather, the gear oil may heat up and expand inside the transmissions. To allow for this oil expansion, both the power unit transmission and the tine attachment transmission have been equipped with oil relief vents (see Figure 6-5). These vents allow small

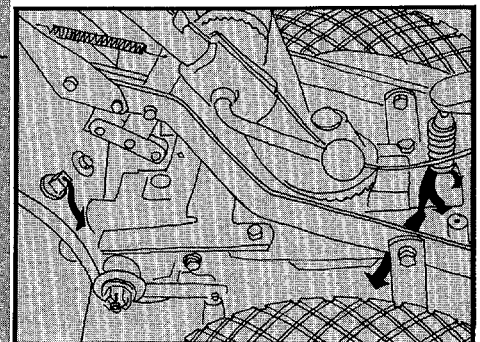

6-5: Location of oil relief vents.

amounts of oil to seep out, thus relieving any excess pressure inside the transmission. You should not be concerned if you see oil leaking from the two oil relief vents. If you discover an oil leak, please call or write our Technical Service Department for parts and service advice. (Be sure to ask about the inexpensive seal drivers that are available for the wheel shaft and tine shaft oil seals.)

B. Checking gear oil levels

At every 30 hours of operation you should check the levels of the gear oil in the power unit and the tine attachment transmissions. Serious damage can result if the transmissions are allowed to run for even a short time without the proper amount of oil.

The transmissions should be cool when checking the oil levels as the oil can expand if hot and thus give a false reading. Also, the power unit and tine attachment must be connected when checking (or adding) gear oil.

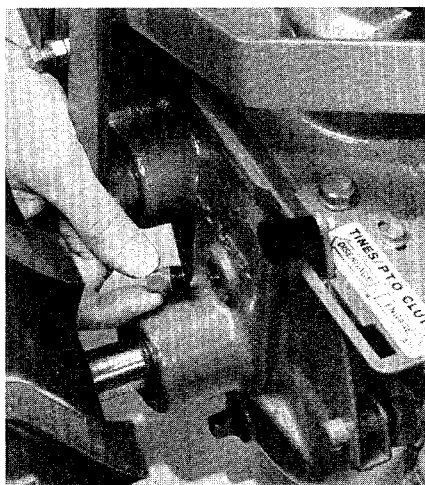

6-6: Remove oil level check plug.

To check the Power Unit oil level:

1. Make sure the tiller is on level ground. Pull the Depth Regulator Lever up until the tines are resting on the ground.
2. Use a 3/8-inch wrench to remove the oil level check plug that is located above the wheel shaft on the left side of the transmission (Photo 6-6).

3. If the oil level is correct, oil should begin to seep out of the hole as you remove the plug (be patient in cold weather as the oil may flow very slowly). If it does, your check is finished and you should securely replace the plug. If there is no sign of oil, see the "Adding Gear Oil" instructions that follow these oil level checking procedures.

To check the Tine Attachment oil level:

1. Make sure the tiller is on level ground.
2. If the tiller has been operated for 30 minutes or more within the last hour, move the Depth Regulator Lever all the way down until it is engaged in its highest notch. This places the transmission in the correct position to take a "Hot" oil level reading.

Don't Base all the way down
 If the tiller has not been operated within the last two hours, you should also place the Depth Regulator Lever in its highest notch. Then, prop up the drag bar (located below the tines) approximately 3 1/2 inches off the ground (using a 2" x 4" board on edge works well). This places the transmission in the correct position to take a "Cold" oil level reading.

3. Allow the tiller to rest in this position for at least five minutes for a "Hot" reading or two hours for a "Cold" reading. (Allow more time if the air temperature is below 40°F).
4. Clean the area around the tine attachment dipstick so that no debris will fall into the transmission.

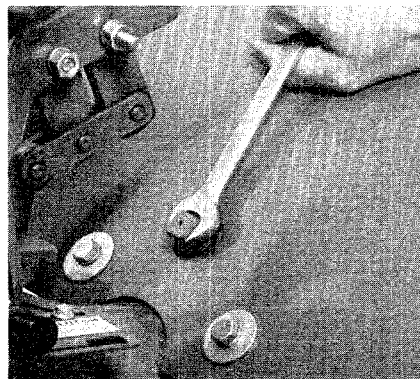

6-7: Remove tine attachment dipstick.

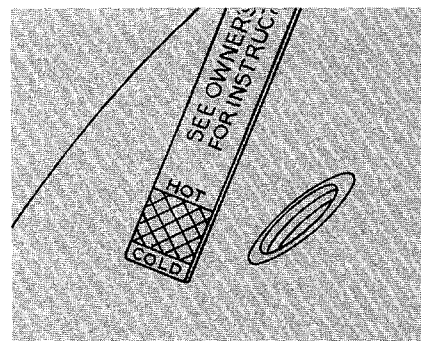

6-8: Tine attachment dipstick markings.

5. Using a 9/16-inch wrench, remove the dipstick as shown in Photo 6-7. Wipe the dipstick with a clean rag and note the "Hot" and "Cold" range markings on one side (Figure 6-8).

6. With the markings facing to the rear of the tiller, gently lower the dipstick straight down into the sump hole until the end just touches the drive shaft inside the hole (Photo 6-9). Do not force, or try to thread the dipstick into the hole. Doing so will bend the dipstick and result in an incorrect reading.

7. After a few seconds, carefully remove the dipstick and look at the markings. If taking a "Hot" reading, the oil level should be within, or slightly above, the "Hot" range marking (checkered pattern). If taking a "Cold" reading, the oil level should be within, or slightly above, the "Cold" range marking.

8. If the oil level is okay, your check is finished and you should securely replace the dipstick. If the oil level is low, see the instructions that follow.

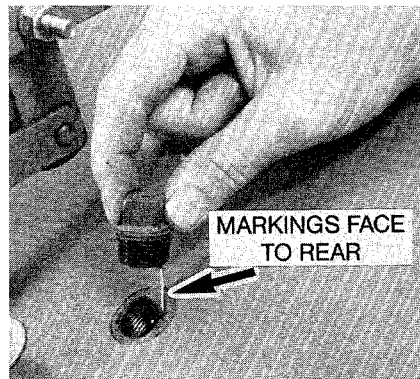

6-9: Insert dipstick straight down.

C. Adding or changing gear oil

For small top-offs (a few ounces or less), use SAE 140, SAE 85W-140 or SAE 80W-90 weight gear oil with an API rating of either GL-3 or GL-5. For full gear-oil replacement, use SAE 140 or SAE 85W-140 gear oil with an API rating of GL-3 only. (Your tiller transmission was filled with SAE 140 weight gear oil at the factory.)

IMPORTANT

Do not use automatic transmission fluid or engine oil in the transmission. These lubricants are too light for transmission use.

The gear oil does not require regular changing. Do so only if you know, or suspect, that it has become contaminated with dirt, sand, or metal particles.

Gear oil should be available at well-stocked service stations, outdoor power equipment stores, or farm or heavy equipment service centers. The power unit transmission holds approximately 60 ounces; the tine attachment holds approximately 16 ounces.

To add oil to the Power Unit transmission:

1. Follow steps 1 and 2 of "To check the Power Unit oil level."
2. Using a $\frac{3}{8}$ -inch wrench or socket, remove the bolt that secures the handlebar base to the top of the transmission (before removing the bolt, support the handlebars with one hand to prevent them from falling on the tine hood). Unplug the Forward Interlock wire harness receptacle at the bottom of the handlebars and gently set the handlebars aside (avoid getting dirt on the wire harness, the mounting bolt, or the handlebar base). The hole in the top of the transmission is the gear oil fill hole. See Photo 6-10.

3. Using a clean funnel, slowly pour fresh gear oil into the transmission. Stop pouring the gear oil when it begins to flow out of the oil level check hole on the left side of the transmission (see Photo 6-6).
4. Reinstall the oil level check plug and tighten it securely.
5. Reinstall the handlebars and tighten the mounting bolt securely. Make certain that the handlebars are pointing straight backwards, and are not angled to one side.
6. Reconnect the Forward Interlock wire harness, making sure that the connection is tight and secure.
7. Test operation of Forward Interlock Safety System. See page 17.

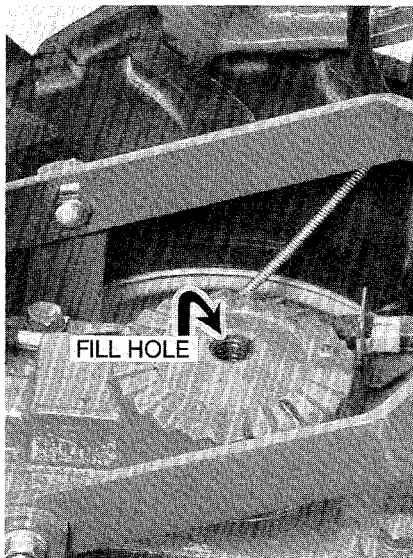

6-10: Remove handlebar base to add gear oil.

To drain the Power Unit transmission:

1. Place a shallow pan beneath the transmission gear oil drain plug (Photo 6-11).
2. Use a $\frac{3}{8}$ -inch wrench to remove the oil level check plug (see Photo 6-6). This vents the transmission and speeds up draining.
3. Use the same wrench to remove the drain plug. The gear oil will drain slowly, so be patient. After about two quarts has drained, gently tilt the tiller forward so that the oil will drain from the rear of the transmission.

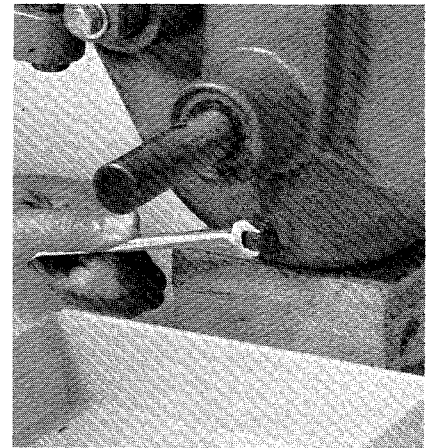

6-11: Remove oil drain plug.

4. After all the gear oil has drained, clean the threads of the oil drain plug, apply a non-hardening gasket sealant to the threads and reinstall the plug.
5. Leave the oil level check plug off if you are going to immediately refill the transmission. If not, replace the check plug for safekeeping.
6. Be certain to refill the transmission with gear oil before operating the tiller again.

To add oil to the Tine Attachment transmission:

1. Select the correct depth regulator lever setting:
 - (a) If filling an empty transmission, raise the Depth Regulator Lever until the tines are on the ground.
 - (b) If you are topping off the gear oil level, move the Depth Regulator Lever all the way down until it is engaged in its highest notch.
2. Remove the dipstick from the tine attachment, after first cleaning the area around the dipstick so that no debris will fall into the transmission (see Photo 6-7).
3. Using a clean funnel, slowly pour oil into the transmission. Add just $\frac{1}{2}$ -ounce at a time, to avoid overfilling the transmission.
4. Take dipstick readings frequently (see Steps 6 and 7 of "To Check the Tine Attachment Oil Level"). When the oil reaches the "Cold" range marking on the dipstick, stop pouring. Replace the dipstick securely.

To drain the Tine Attachment transmission:

1. The tine attachment transmission is not equipped with an oil drain plug. To drain a small amount of oil, remove the dipstick and tilt the attachment forward (after first uncoupling it from the Power Unit).
2. For complete draining, remove the left side tine assembly (refer to "Bolo Tine Maintenance" for instructions) and then remove one of the lower screws from the tiller housing cover (Photo 6-12). To speed up the draining time, remove the dipstick to help vent the transmission.

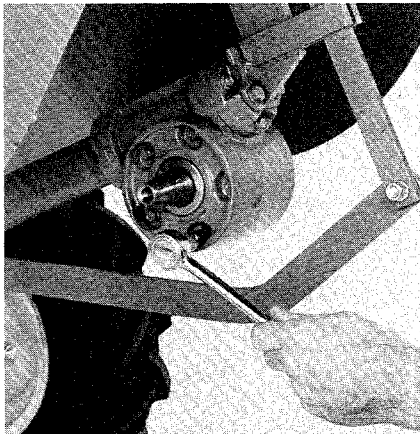

6-12: Remove housing cover screw to drain oil.

NOTE: There may be a disposable plastic washer on the screw. If there is, discard it after removing the screw. There is no need to install a replacement washer on the screw.

3. After all the gear oil has drained, reinstall the housing cover screw after first coating its threads with non-hardening gasket sealant.
4. Be certain to refill the transmission with gear oil before operating the tiller again.

Drive belt maintenance

! WARNING

To help avoid personal injury, stop the engine, remove the electric start key, disconnect the spark plug wire, and let the engine and muffler cool before inspecting, adjusting or replacing the drive belt.

A. Checking drive belt tension

On a new tiller (or if a new belt is installed), the tension on the drive belt will probably need to be adjusted after the first 2 hours of operation due to initial belt wear and seating of the belt with its pulleys. Following the initial adjustment, the belt should be checked after every 10 operating hours or whenever it appears to be slipping (reduced performance).

Maintaining the correct tension on the belt is important to good tilling performance and long belt life. If the belt is too loose, it will slip on the engine and transmission pulleys and cause the tines and wheels to slow down—or stop completely—even though the engine is running with full power. At the same time, a loose belt will result in uneven wear and overheating to its sidewalls. This will reduce its driving capability and shorten its life.

While checking the belt for proper tension, also look for obvious signs of wear such as cracks, cuts, or fraying. If the belt is in poor condition, it should be replaced immediately (see "Replacing the Drive Belt").

To help prolong the life of the belt, you should:

- (a) Always put the Wheels/Tines/PTO Drive Lever in "NEUTRAL" when the tiller is not being used.
- (b) Keep the belt tension properly adjusted.
- (c) Avoid "speed shifting" between "FORWARD" and "REVERSE".

How to measure belt tension:

1. Before taking any measurements, make sure that the various linkages and pivot points on the Wheels/Tines/PTO Drive Lever are clean and properly lubricated. If there is any binding, you won't receive true measurements. Also, you should have available the belt adjustment tool that you received with your new tiller (Figure 6-13).

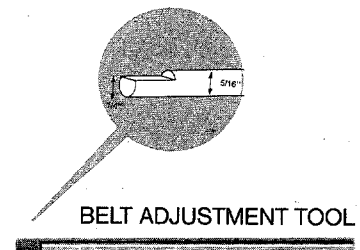

6-13: Use belt adjustment tool to measure and adjust belt tension.

2. Move the Wheels/Tines/PTO Drive Lever all the way down to the "FORWARD" position. The clutch roller at the end of the lever should be engaged beneath the belt adjustment block (Photo 6-14). Be careful not to let the clutch roller move during the following steps. If the roller moves, you will receive a false reading of the belt's tension.

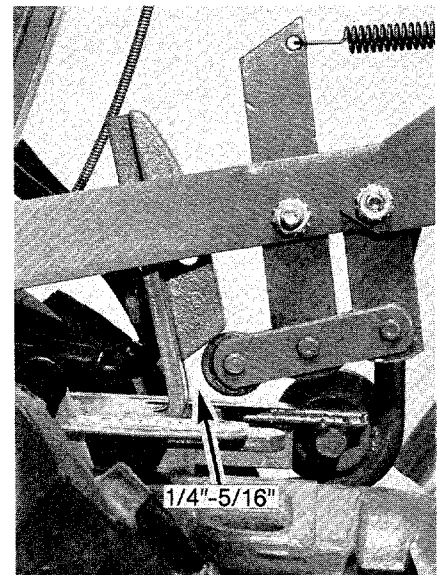

6-14: Shift into "FORWARD" and measure distance between roller and upright bracket.

3. The belt tension is correct if the front of the clutch roller is 1/4 to 5/16-inches away from the face of the upright bracket that holds the adjustment block in place (Photo 6-14). To measure this distance:

- (a) Without moving the clutch roller, try to insert the 1/4-inch thick, slotted end of the belt adjustment tool in between the roller and the bracket. The flat edge of the tool must be facing the roller. See Photo 6-15.
- (b) If only the slotted end of the tool will fit, the belt is properly adjusted. This 1/4-inch gap is ideal.
- (c) If the slotted end will not fit, the belt is too loose.
- (d) If the full thickness (5/16-inch) of the tool easily fits, the belt is too tight.

4. If the belt tension is correct, return the shift lever to the "NEUTRAL" position and check the tension again after the next 10 operating hours. If the belt is too loose or too tight, refer to the adjustment instructions that follow.

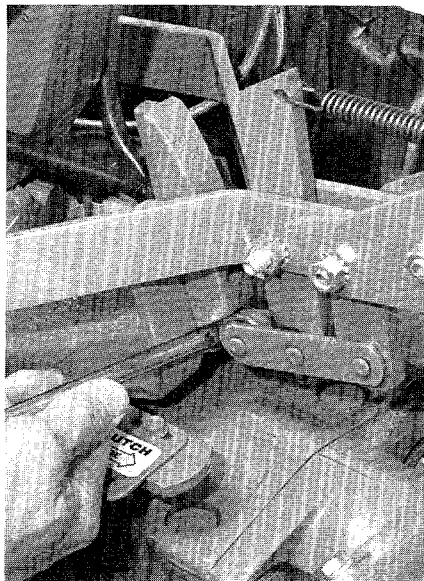

6-15: Insert slotted end of belt adjustment tool between roller and bracket, with flat side of slot facing roller.

How to adjust belt tension:

1. The tension on the drive belt is adjusted by moving the belt adjustment block either down to tighten the belt, or up to loosen the belt.

As a rule of thumb, the distance the block moves will approximately equal the distance the roller moves. In most cases, the clutch roller will not have been very far out of position, and therefore only a slight movement of the block will be required.

2. Place the Wheels/Tines/PTO Drive Lever in "NEUTRAL". The clutch roller will come to rest anywhere on the face of the belt adjustment block, depending upon drive belt length and future adjustments for belt tension.

3. Insert the belt adjustment tool through the hole in the side of the adjustment block, spacing the ends of the tool equally on both sides (Photo 6-16). Rotate the tool so that the slotted end is facing down.

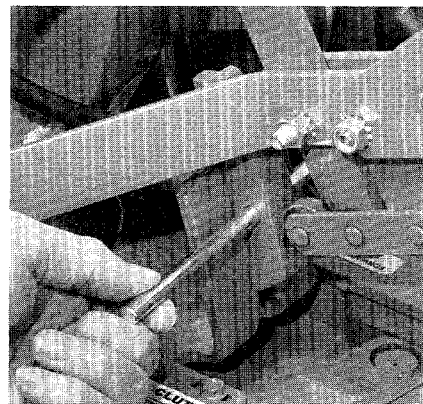

6-16: With shift lever in "NEUTRAL", insert tool through hole in adjustment block.

4. Place the Wheels/Tines/PTO Drive Lever in "FORWARD". The arms of the clutch control yoke will be resting on the belt adjustment block and the clutch roller should be engaged slightly beneath the adjustment block (Photo 6-17).

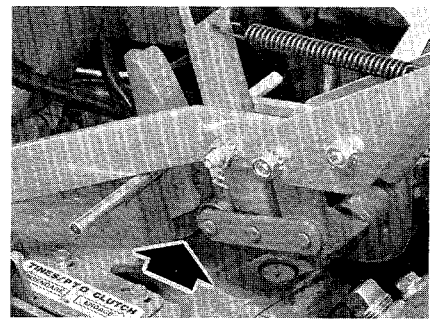

6-17: With shift lever in "FORWARD", clutch roller should be engaged slightly beneath adjustment block.

5. Use one hand to hold the drive lever in "FORWARD" while using a 9/16-inch wrench to loosen (do not remove) the bolt in the back of the belt adjustment block (Photo 6-18).

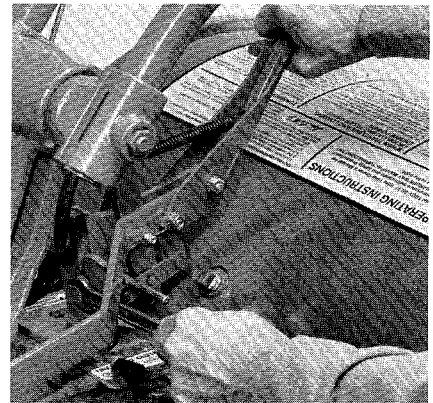

6-18: Hold lever while loosening bolt. Push lever down to tighten belt or pull up to loosen belt.

6. Push the drive lever down if the belt needs tightening, or pull the lever up if the belt needs loosening. The adjustment block should move freely in either direction. Hold the drive lever in place and securely tighten the bolt in the adjustment block.

7. Let go of the drive lever and remove the belt adjustment tool from the hole in the adjustment block.

8. Check the tension on the belt by following the previous "How to Measure Belt Tension" instructions. **NOTE:** If the adjustment block has moved all the way down in its bracket and you still measure less than 1/4-inch between the clutch roller and the bracket, then the belt has worn too much and a new one is needed.

C. Replacing the drive belt

! WARNING

To help avoid personal injury, stop the engine, remove the electric start key, disconnect the spark plug wire, and let the engine and muffler cool before removing or replacing the drive belt.

To remove the belt:

1. Place the Wheels/Tines/PTO Drive Lever in "NEUTRAL".
2. While kneeling on the right side of the tiller, create slack in the belt by reaching over to the left side of the pulleys and pushing in on the center of the belt with your finger.
3. Use your right hand to work the belt down and away from the lower pulley, in the direction of the engine (Photo 6-19).

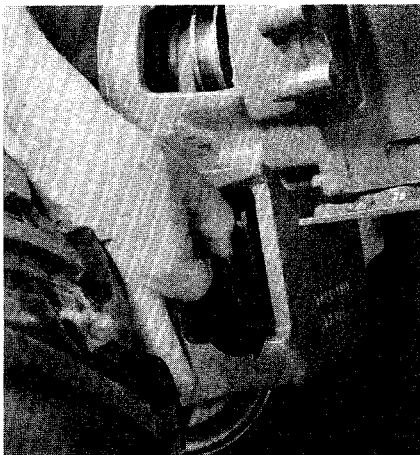

6-19: Move belt off lower pulley.

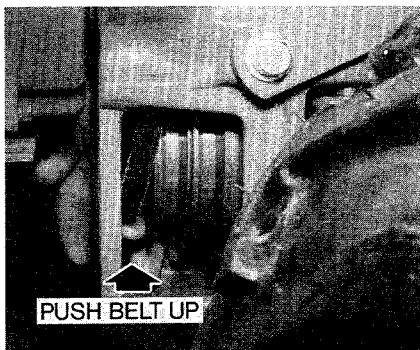

6-20: Push belt upward to create slack.

4. As shown in Photo 6-20, push the belt upward with your finger. This will provide additional slack in the belt.
5. Lift the top half of the belt up and over the upper pulley and the rubber reverse disc, moving it down in front of the disc (Photo 6-21).
6. Move the Wheels/Tines/PTO Drive Lever down into the "FORWARD" position. This increases the distance between the upper and lower pulleys. Next lift and pull the lower half of the belt out between the pulleys (Photo 6-22).

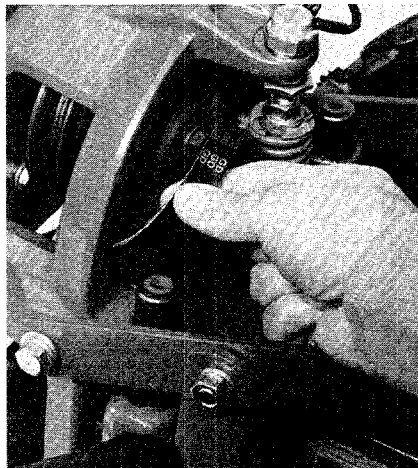

6-21: Move top half of belt over pulley and disc.

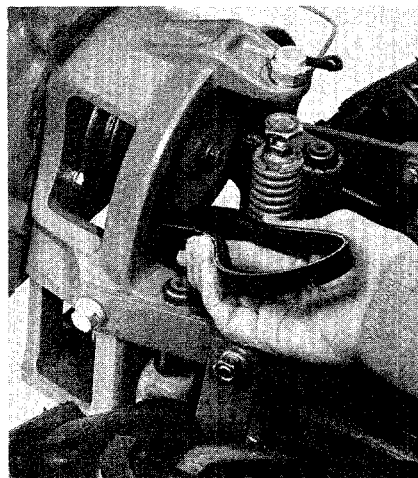

6-22: Shift into "FORWARD" and remove belt.

To replace the drive belt:

1. Place the Wheels/Tines/PTO Drive Lever in the "FORWARD" position.
2. Squeeze the belt in its middle and insert one end in between the pulleys (Photo 6-23).

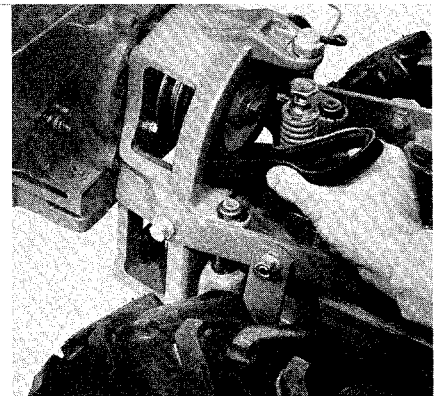

6-23: Shift into "FORWARD" and insert belt.

3. Push the belt forward until it is almost ready to go down and over the front of the lower pulley (Photo 6-24). Then work the belt down and over the lower pulley, but do not seat it in either of the pulley grooves. It may be necessary to use a blunt object (such as a wood ruler), to help push the belt down between the front of the pulley and the sides of the cast iron engine mount.

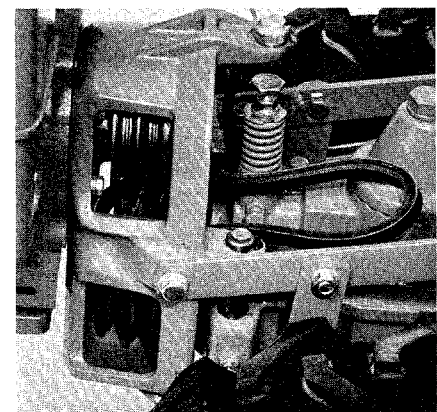

6-24: Move belt down and over lower pulley.

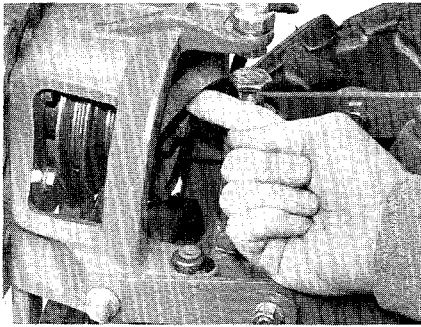

6-25: Move belt over reverse disc.

4. Move the top half of the belt up and over the rubber reverse disc, but do not seat it in either of the pulley grooves (Photo 6-25).

5. Place the Wheels/Tines/PTO Drive Lever in "NEUTRAL".

6. Move the top half of the belt into the "HIGH RANGE" groove (groove closest to the engine) of the upper pulley (Photo 6-26).

Make sure the belt is fully seated on both sides of the upper pulley.

7. Move the bottom half of the belt into the "HIGH RANGE" groove (groove closest to engine) of the lower pulley (Photo 6-26). If extra belt slack is needed, hold the Wheels/Tines/PTO Drive Lever up in "REVERSE" while moving the belt. Make sure the belt is fully seated on both sides of the lower pulley.

8. To move the belt to the "LOW RANGE" position, refer to "Changing Belt Speeds" in Section 3.

9. After installing the belt, check and adjust for correct tension as explained previously.

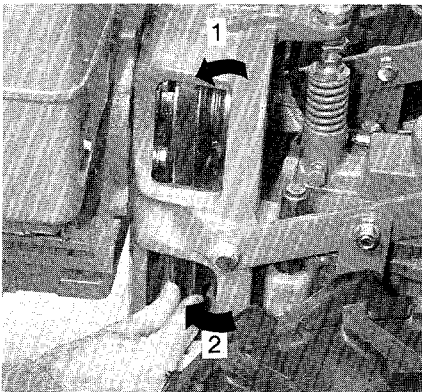

6-26: Seat belt in upper pulley, then lower pulley ("HIGH RANGE" position shown).

Reverse drive maintenance

WARNING

To help avoid personal injury, stop the engine, remove the electric start key, disconnect the spark plug wire, and let the engine and muffler cool before inspecting, adjusting or replacing the reverse drive components.

When you raise the Wheels/Tines/PTO Drive Lever all the way up for "REVERSE", it lowers the rotating rubber reverse disc on the end of the engine pulley until it contacts the transmission drive pulley. The resulting friction between the reverse disc and the transmission pulley causes the transmission drive shaft to be driven in a counterclockwise direction (as viewed from the operator's position behind the handlebars). The drive shaft then turns the wheel and tine shafts in a reverse direction.

The following instructions explain how to inspect, replace or adjust the various reverse drive components.

A. Reverse disc inspection

The reverse disc is made of a steel disc with a special long-lasting rubber compound bonded to the rim. Because it is a wearing part, the reverse disc should be inspected after each 30 hours of operation.

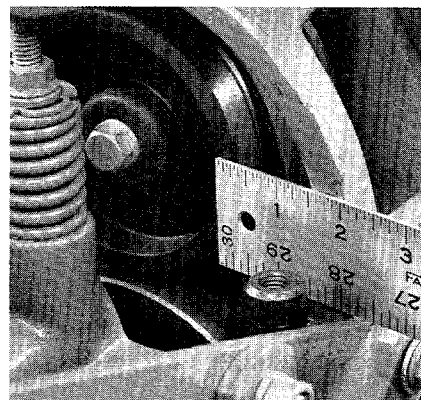

6-27: Measure disc edge for wear.

1. Measure the width of the facing edge on the disc, as shown in Photo 6-27. The disc should be replaced before the edge is allowed to reach $\frac{1}{8}$ -inch thickness. If the edge wears further than that, then only the metal plate will remain and it could cause costly damage if allowed to come in contact with the transmission pulley.
2. Look for large cracks or missing chunks of rubber (small nicks or gouges are okay, but keep a close watch on them). A disc having large cracks or gouges should be replaced immediately.

IMPORTANT

You can help extend the life of the reverse disc by always pausing in "NEUTRAL" before shifting between "FORWARD" and "REVERSE". Also remember that the reverse disc is not designed for long periods of continuous reverse operation. Use reverse drive sparingly.

B. Replacing the reverse disc

Follow these simple steps to remove and replace the reverse disc. If your tiller is equipped with a Bumper/Guard Attachment, you will have to remove the bumper to give yourself enough working room.

To remove the reverse disc:

1. Place the Wheels/Tines/PTO Drive Lever in "NEUTRAL".

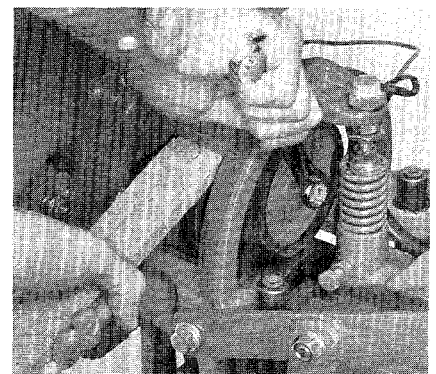

6-28: Wedge pulley with board and loosen bolt.

C. Checking and adjusting reverse drive

! WARNING

To help avoid personal injury, stop the engine, remove the electric start key, disconnect the spark plug wire, and let the engine and muffler cool before inspecting or adjusting the reverse drive components.

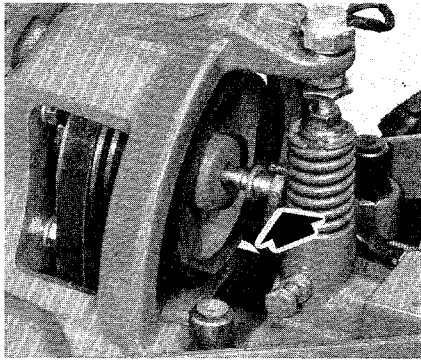

6-29: Loosen, but do not remove bolt.

2. To prevent the reverse disc and its mounting bolt from turning as you try to remove the bolt, first place a 5/16-inch thick board between the top of the engine pulley (avoid the disc and drive belt) and the cast iron engine mount (Photo 6-28).
3. Working from the left side of the tiller, place the boxed end of a 9/16-inch wrench on the mounting bolt. Then pull up hard on the stick and push down sharply on the wrench. This sharp push with the wrench should break the bolt loose without also causing the pulley to turn.
4. Loosen the bolt until it just touches the reverse spring and plunger assembly (Photo 6-29). Don't try to remove the bolt just yet.
5. Use a screwdriver to separate the disc from the engine pulley (Photo 6-30).
6. Slide the disc out until it touches the head of the mounting bolt. Then angle the disc a little to the left and remove the bolt and its lockwasher (Photo 6-31). Now remove the disc.

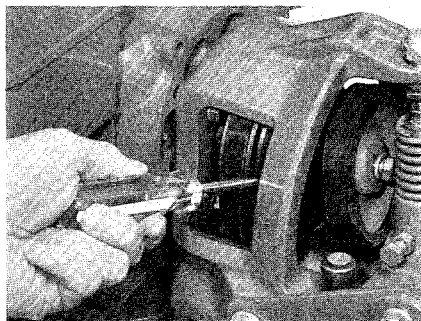

6-30: Use screwdriver to separate disc from engine pulley.

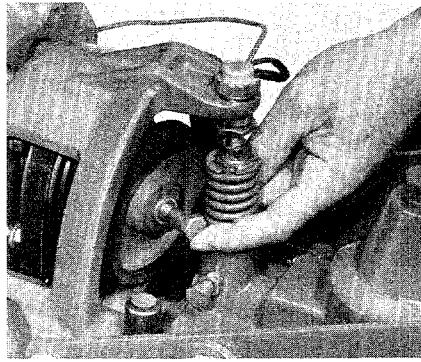

6-31: Angle disc to remove or install mounting bolt.

To replace the reverse disc:

1. One side of the disc has a raised shoulder in its center. When installing the disc, this shoulder must be facing away from the engine pulley.
2. With the Wheels/Tines/PTO Drive Lever in "NEUTRAL", insert the disc in front of the engine pulley and angle it as shown in Photo 6-31. Put the lockwasher on the bolt and insert the bolt through the disc.
3. Hold the disc against the engine pulley and hand-tighten the bolt as far as you can.
4. To fully tighten the bolt, place the 5/16-inch thick board in between the top of the engine pulley (avoid the disc and belt) and the engine mount (Photo 6-32). Now pull up hard on the board while you tighten the bolt with the wrench.
5. Check for correct reverse drive operation by referring to the following instructions.

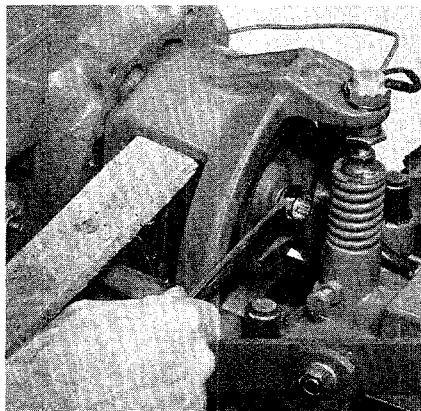

6-32: Wedge pulley with board and tighten bolt.

When the Wheels/Tines/PTO Drive Lever is shifted into "REVERSE", the engine and the engine mount move down to press on the reverse adjustment bolt (Photo 6-33). This action compresses the reverse spring and plunger assembly, requiring you to hold the lever up in "REVERSE". When you let go of the lever, the spring automatically pushes the lever back into "NEUTRAL".

The spring and plunger assembly is designed to prevent the reverse disc from making contact with the transmission pulley until you decide to shift into "REVERSE". When the lever is in "NEUTRAL", the switch body on the bottom of the engine mount tab should be resting squarely on top of the reverse adjustment bolt (Photo 6-33). The reverse adjustment bolt can be adjusted up or down to correct a number of reverse drive operating problems, as explained next.

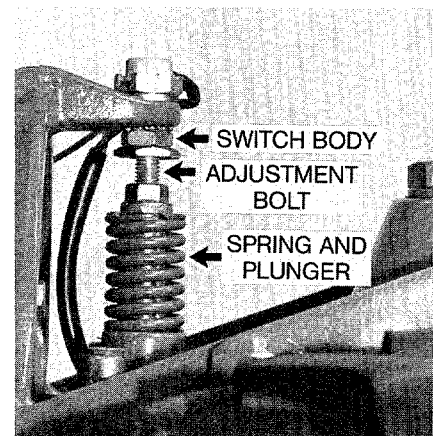

6-33: Spring and plunger assembly.

Check action of reverse disc:

1. Make certain that the linkages for the Wheels/Tines/PTO Drive Lever are lubricated with oil and the engine mount bars and the belt adjustment block are lubricated with grease. See "Tiller Lubrication" in this Section for instructions.

2. Place the Wheels/Tines/PTO Drive Lever in "NEUTRAL". Now pull the engine starter rope, briefly, while watching the reverse disc. The reverse disc should turn, but the lower pulley should not (Photo 6-34). If the reverse disc turns the lower pulley, or if it is located

closer than 3/16-inch to the lower pulley, then the reverse adjustment bolt should be adjusted upward, as explained in the adjustment instructions that follow. Moving the reverse adjustment bolt upward will also correct the problem of a tiller that goes into reverse by itself.

3. Use your left hand to hold the Wheels/Tines/PTO Drive Lever up in "REVERSE", while you briefly pull the engine starter rope with your right hand. The reverse disc should turn the lower pulley (Photo 6-35). If it doesn't, or if it takes a great deal of pressure to hold the

lever up in the reverse position, then the reverse adjustment bolt should be adjusted downward. When adjusted correctly, the Wheels/Tines/PTO Drive Lever should "pop" out of reverse when the lever is released, but it should not require exceptional effort to hold it in the reverse position.

4. Shift the Wheels/Tines/PTO Drive Lever into "REVERSE" and then let it go. The lever should return to "NEUTRAL". If it doesn't, the reverse adjustment bolt will have to be raised upward.

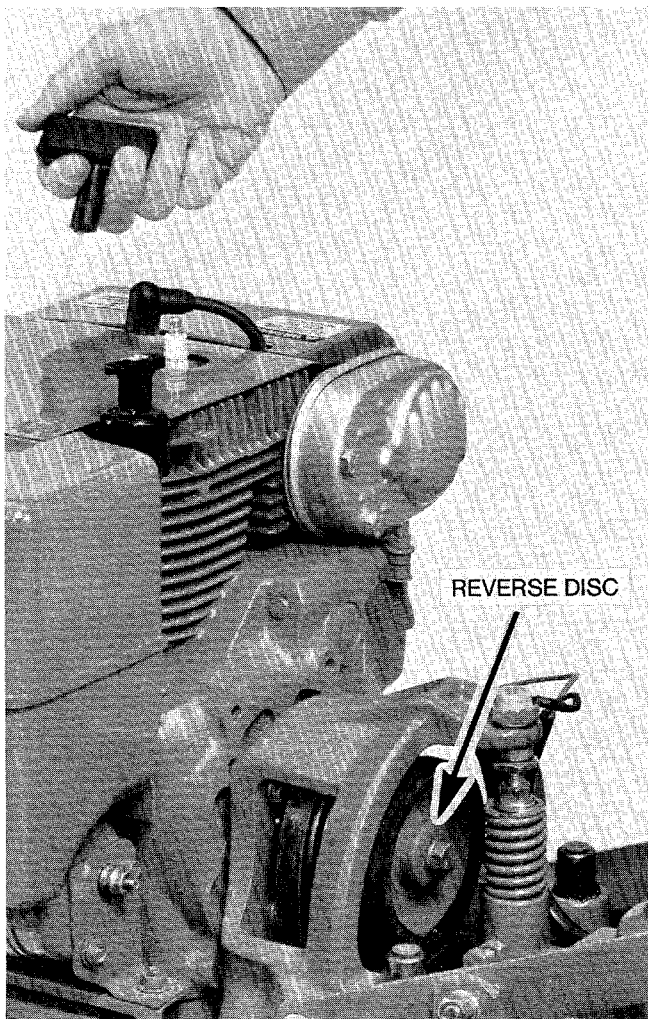

6-34: With shift lever in "NEUTRAL", only the reverse disc should turn.

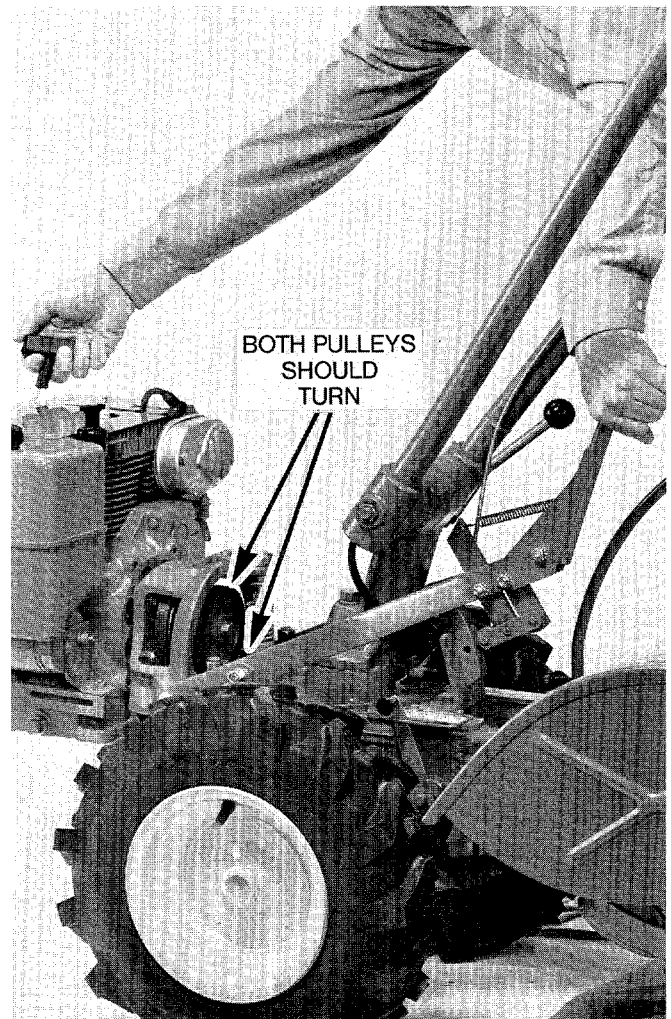

6-35: With shift lever in "REVERSE", the reverse disc should turn the transmission pulley.

Adjusting reverse drive

1. Place the Wheels/Tines/PTO Drive Lever in "FORWARD".
2. On the left side of the tiller, place a 1/2-inch wrench on the plunger retaining bolt and another 1/2-inch wrench on the jam nut next to it (Photo 6-36). While holding the bolt steady, loosen the jam nut (counterclockwise) until it touches the head of the bolt.

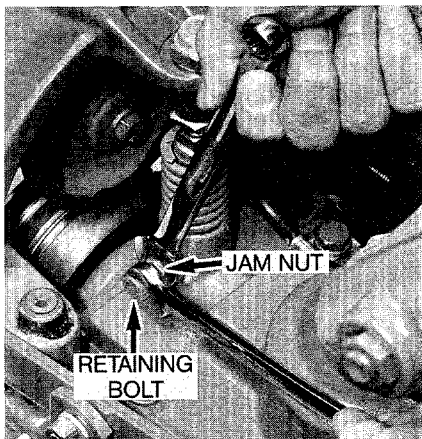

6-36: Hold bolt steady while loosening or tightening jam nut.

3. Turn the bolt inward until it tightens against the plunger inside the spring. The bolt must be tight enough to prevent the plunger from turning, but be careful not to overtighten and break the bolt.
4. Place a 7/8-inch wrench on the head of the reverse adjustment bolt and another 9/16-inch wrench on the jam nut below it (Photo 6-37). Hold the bolt steady while loosening the jam nut three or four turns.
5. Place the Wheels/Tines/PTO Drive Lever in "NEUTRAL". The switch body on the bottom of the engine mount tab should be resting squarely on top of the reverse adjustment bolt (see Photo 6-33), and the reverse disc should be at least 3/16-inch away from the transmission drive pulley. If the reverse disc is closer than 3/16-inch, raise the reverse adjustment bolt by turning it in a counterclockwise direction.

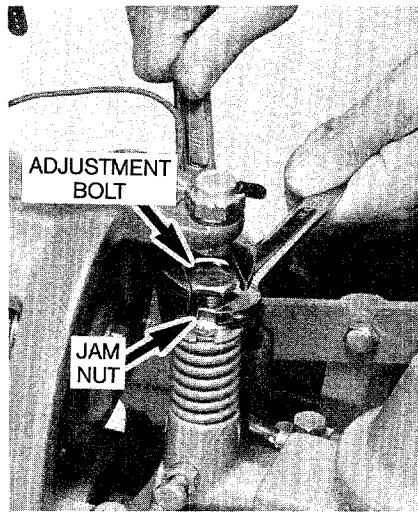

6-37: Loosen jam nut before raising or lowering reverse adjustment bolt.

6. Check that the reverse disc is at least 3/16-inch away from the transmission drive pulley. Then hold the reverse adjustment bolt steady with one wrench while securely tightening the jam nut with a second wrench. See Photo 6-37.

7. Place a chalk or pencil mark on the top edge of the plunger retaining bolt. Now, while watching the mark, loosen the bolt a full 3/4 turn (Photo 6-38). Do not exceed a 3/4 turn. Doing so could disengage the bolt from the locking groove in the side of the plunger.
8. Hold the plunger retaining bolt steady with one wrench while securely tightening the jam nut against the side of the plunger housing with a second wrench. See Photo 6-36.
9. Check the action of the reverse disc as explained in the previous testing procedure.

IMPORTANT

If the above adjustments have not corrected an improperly functioning reverse drive, please call or write our Technical Service Department for further advice.

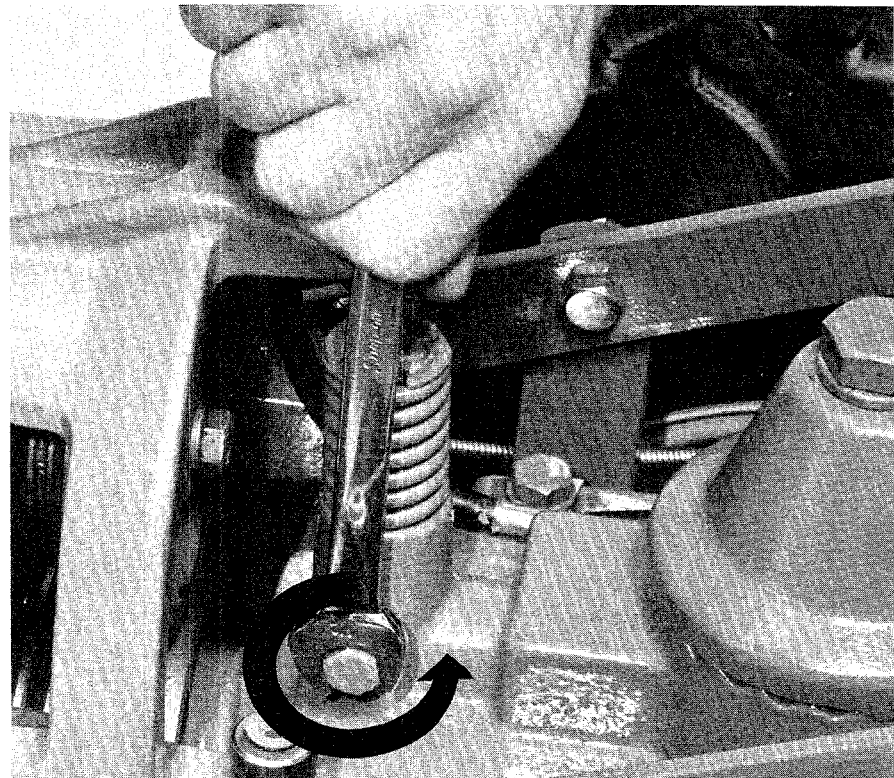

6-38: Loosen plunger retaining bolt a 3/4 turn, then tighten jam nut securely against plunger housing.

Bolo Tine maintenance

WARNING

To help avoid personal injury, stop the engine, remove the electric start key, disconnect the spark plug wire, and let the engine and muffler cool before inspecting, removing, or replacing the tines or tine holders.

A. Checking tines for wear

To receive maximum tilling performance from your tiller, the Bolo Tines must be in good condition. At every 30 operating hours you should check the tines for damage or excessive wear and replace them if needed.

The tines are the “business end” of the machine and will wear with use. How quickly they wear depends a great deal on soil conditions. Sandy or stony soil, for instance, will cause faster wear than clay or loam soils.

As tines wear, they become shorter, narrower and more pointed

(Photo 6-39). When badly worn, the depth at which they till and the amount of earth turned is greatly reduced. Worn tines may dig only 3 to 5-inches deep, even though you adjust the Depth Regulator Lever to the maximum depth. In comparison, new tines will dig a full 6 to 8-inches deep. This loss of tilling depth is a sure sign that your tines need replacing.

Also, as tines wear shorter, they will leave an increasingly wider gap in the middle of the tilled row. This wider gap makes for needless extra work when you overlap your rows. New tines will usually have just a 3-inch gap between the tips of the innermost tines. It's time to replace your tines when this gap widens to 5-inches or more (Photo 6-40).

Tines can be replaced individually or as a complete set (tine sets come with easy-to-follow assembly instructions). See your separate Parts Catalog for tine replacement ordering information.

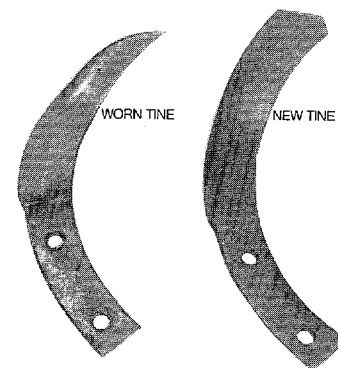

6-39: Check for tine wear.

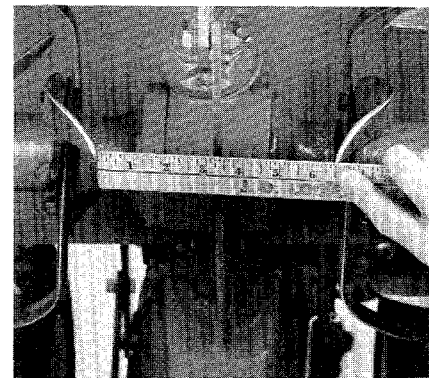

6-40: Replace tines when gap between inner tines is 5-inches or more.

B. Single tine replacement

WARNING

The tines or tine hood edges may be sharp. Wear thick gloves to protect your hands from cuts or scrapes.

1. Place the Wheels/Tines/PTO Drive Lever in “NEUTRAL”, the Wheel Speed Lever in either “FAST” or “SLOW”, and the Tines/PTO Clutch Lever in “ENGAGE”.
2. Gently tilt the tiller forward until the engine is resting on the ground.
3. Raise the hood flap and secure it in place with a piece of string or a rubber band.
4. Before removing a tine, carefully note in which direction the bent tip is pointing. The new tine must be installed in the same direction.



6-41: Removing a single tine.

5. Use two 9/16-inch wrenches to remove the two bolts and hex nuts that secure the tine to the tine holder mounting plate (Photo 6-41). If a nut is stubborn, squirt some penetrating oil on it and allow the oil to soak in.

6. Install the new tine in the same direction as the old one, making sure that the sharp edge of the tine will enter the soil first when the tiller moves forward. Replace the bolts and nuts and tighten them securely.

C. Removing and replacing tine holders

The 16 Bolo Tines are held in place by tine holders that are bolted to the left and right sides of the tine shaft. The following steps explain how to remove and replace the tines and holders as complete assemblies.

Removal Steps:

1. Follow steps 1-3 of the previous “Single Tine Replacement” instructions.

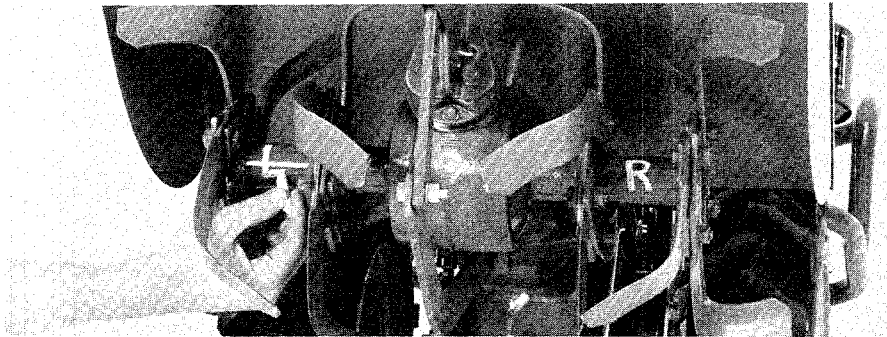

6-42: Mark left and right holders.

! WARNING

The tines or tine hood edges may be sharp. Wear thick gloves to protect your hands from cuts or scrapes.

2. Before removing the holders, use chalk to mark them "Left" and "Right", as shown in Photo 6-42. This will help you later, when you replace the holders.
3. Using a 3/4-inch wrench, remove the bolt, lockwasher and flat washer that mounts the holder to the tine shaft (Photo 6-43). If the bolt is difficult to loosen, hold the boxed end of the wrench on the bolt and give the wrench a sharp tap with a soft mallet.

! WARNING

Do not strike the wrench with a metal tool. Doing so could cause the wrench or tool to shatter, resulting in flying metal fragments that could injure your eyes. Wear safety goggles to protect your eyes.

4. Use a soft mallet to drive the holder off the tine shaft. If necessary, use a heavy hammer and a long steel rod or hardwood board placed against the back of the inside mounting plate to drive the holder off.

! WARNING

Wear safety goggles to protect your eyes from flying metal or wood fragments.

5. As you remove the holder, look for a small, rectangular shaped metal key (1" x 3/16") either in the keyslot of the tine shaft or in the keyway of the tine holder (Photo 6-44). Do not lose this key. It should be securely installed in the tine shaft by tapping it down gently with a hammer (be careful not to damage the edges of the key).
6. Clean off any dirt or debris from the shaft and from inside the holders. Doing so will help to prevent wear to the tine shaft and oil seals. When cleaning, be careful not to scratch or gouge the tine shaft or the oil seals. Finally, apply a coating of grease to the tine shaft to help prevent the holders from binding to the shaft.

Replacement steps:

1. When replacing the holders, always make certain that the cutting edge of the tines are facing in the direction of forward tiller travel. Carefully align the keyway in the holder with the key in the tine shaft and tap the holder into place with a soft mallet.
2. Apply some grease to the threads of the mounting bolt to make removal easier the next time.

Tine shaft maintenance

After every 10 operating hours, you should remove the left and right side Bolo Tine holders and clean off any dirt, vines or straw that may have accumulated on the shaft or inside the holders. If left

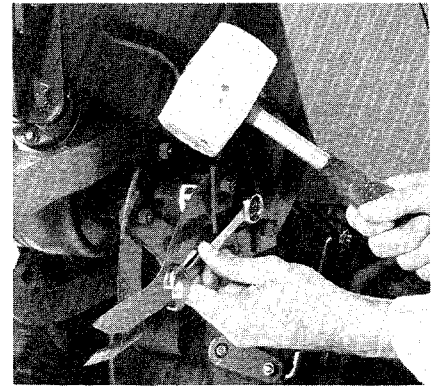

6-43: Remove holder mounting bolt.

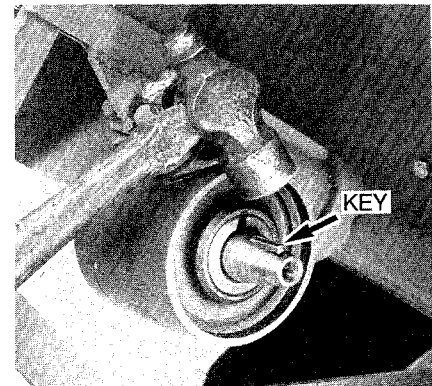

6-44: Install key in keyslot.

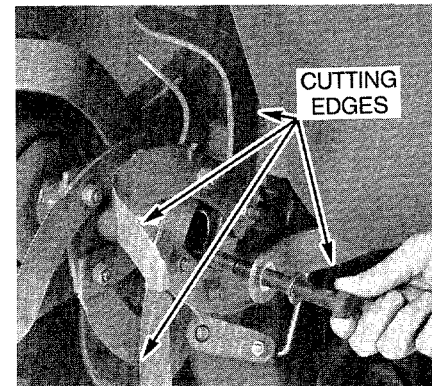

6-45: Replace mounting bolt.

3. Place the lockwasher on the bolt, followed by the flat washer (Photo 6-45). Tighten the bolt securely.

unattended, this debris can cause premature wear to the shaft and its oil seals.

Refer to the previous tine holder removal instructions for the procedure to follow.

Tire and wheel maintenance

The air pressure in the tires should be checked after every 30 operating hours. The recommended air pressure for tilling is 10 to 20 psi (pounds per square inch).

Use a pocket-type tire gauge to ensure that both tires are equally inflated. If the air pressures are not equal, it can cause the tiller to pull to one side.

Keep the tires free of gasoline or oil which can destroy the rubber. **NOTE:** When installing bar tread tires, make sure that the “V” shaped treads are facing forward, in the direction of the engine.

Removing the wheels

WARNING

To help avoid personal injury, stop the engine, remove the electric start key, disconnect the spark plug wire, and let the engine and muffler cool before removing or replacing the wheels.

Each wheel is held in place by a roll (spiral) pin that secures the wheel hub to the wheel shaft. Simply drive out the roll pin to remove a wheel, as explained below.

1. Using a sturdy block, prop up the transmission until the wheels are an inch or two off the ground.

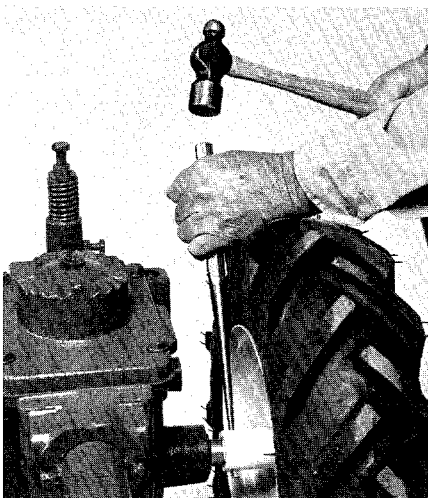

6-46: Drive roll pin out to remove wheel.

2. To prevent the wheels from turning, place the Wheel Speed Lever in either the “SLOW” or “FAST” wheel speed gear.

3. Use either a 3/16-inch tapered drift pin, a 1/4-inch untapered drift pin, or a 16-penny (16d) nail with a blunted point, to drive the roll pin down through the wheel hub (Photo 6-46).

WARNING

Wear safety goggles to protect your eyes from the possibility of flying metal fragments when driving the roll pin into or out of the wheel hub.

4. If the wheel doesn't slide easily off the shaft, squirt some penetrating oil around the shaft and wheel hub and tap the tire to set up vibrations which will help to distribute the oil. Be patient and allow sufficient time for the oil to soak in.

5. Before installing the wheel, apply a thin coating of grease to the wheel shaft. Then, install the wheel and align the roll pin holes by inserting your drift pin or nail from underneath (Photo 6-47). Use a hammer to tap in the roll pin flush with the wheel hub.

NOTE: If a roll pin is loose, you can hold it in place with an automotive engine hose clamp.

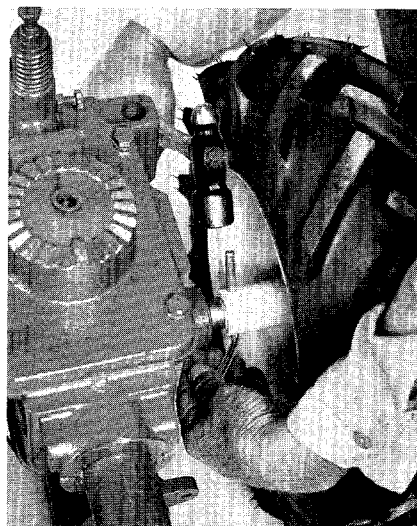

6-47: Align holes and tap in roll pin.

Engine oil maintenance

It is vitally important that you use motor oil of the proper service grade and viscosity, and that you regularly check and change the oil according to the recommended hours of operation. Incorrect, insufficient, or dirty oil will cause premature engine wear and damage.

Check the oil level each time before starting the engine and after each 5 hours of continuous operation.

Change the oil after the first 5 hours of new engine operation. Thereafter, change the oil after each 10 operating hours, or more often if operated in extremely dusty or dirty conditions.

NOTE: The engine manufacturer recommends oil changes after each 25 operating hours. However, please remember that your tiller will nearly always be operating in dusty or dirty conditions, which is why we recommend a 10-hour service schedule.

Use a clean, high-quality detergent motor oil. The oil should be rated with an SF or SG service classification (look for those letters on the container).

The oil sump capacity for the Briggs & Stratton engine is approximately 2 $\frac{1}{4}$ pints; however always add enough oil so that it is to the point of overflow in the oil filler tube. For the Kohler Engine the capacity is approximately 32 ounces; however always fill to the “FULL” mark on the dipstick.

Always use the correct viscosity according to the air temperature at the time of operation (see chart that follows).

WARNING

To help avoid personal injury, stop the engine, remove the electric start key, disconnect the spark plug wire, and let the engine and muffler cool before checking, adding, or changing engine oil.

RECOMMENDED SAE VISCOSITY GRADES

ENGINE MODEL	AIR TEMPERATURE	OIL VISCOSITY
7 HP Briggs & Stratton	40°F to 100°F	SAE 30W
	0°F to 40°F	SAE 5W30 or SAE 10W30
	-20°F to 40°F	Synthetic 5W20 or 5W30
8 HP Kohler	Above 32°F	SAE 30
	0°F to 32°F	SAE 10W30, SAE 10W40
	-20°F to 32°F	SAE 5W20, SAE 5W30

A. Checking engine oil level

7 HP BRIGGS & STRATTON:

1. Stop engine and allow to cool.
2. Level the base of the engine.
3. Remove oil fill plug from either side of engine (clean plug before removing.) See Photo 6-48.
4. Oil level should be at overflow point of oil fill tube. If not, slowly add oil until it reaches overflow point.
5. Replace oil fill plug securely.

8 HP KOHLER:

1. Stop engine and allow to cool.
2. While on level ground, move Depth Regulator Lever all the way down until it engages top notch in lever. This places base of engine at a slight angle.
3. Remove dipstick (clean area around dipstick before removing) and wipe clean.
4. Reinsert dipstick and push it all the way down into tube. Remove dipstick and check level. Oil should be up to, but not over, the "F" mark on dipstick. See Photo 6-49. If below "F" mark, slowly add oil, checking level frequently with dipstick. Do not operate engine with oil level below "L" mark or over "F" mark.
5. Replace the dipstick securely.

B. Changing engine oil

1. Drain the oil while the engine is still warm from recent operation as warm oil drains more easily and also carries away more impurities. Be sure to stop the engine before changing the oil.

2. There are two oil drain plugs, one on each side of the engine. Either plug may be used.

NOTE: The 7 HP Briggs & Stratton engine is equipped with a balance weight located beneath the engine base (Photo 6-50).

To prevent a messy spill when draining the oil, either temporarily remove the weight, or fashion a drain trough from a piece of aluminum foil or cardboard and hold it beneath the drain hole while the oil

drains. Be sure to replace the balance weight when finished.

3. Place a board beneath the wheel opposite the drain plug you are using.
4. Place a pan beneath the drain plug.
5. Remove oil fill plug (7 HP engine) or dipstick (8 HP engine) to vent crankcase.
6. Remove the drain plug and allow all of the oil to drain into the pan. See Photo 6-50 or 6-51.
7. Clean the drain plug threads and reinstall it in the drain hole. Make sure that you tighten it securely.
8. Refill the engine crankcase with fresh oil as explained in the previous "Checking Engine Oil Level" instructions.
9. Reinstall plug or dipstick.

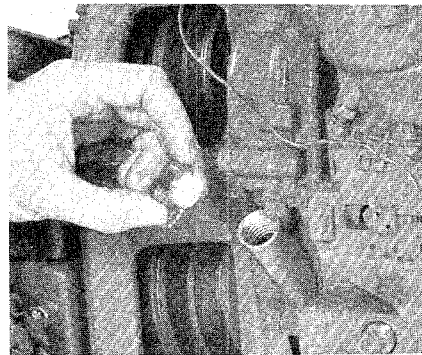

6-48: Checking oil level on 7 HP Briggs & Stratton engine.

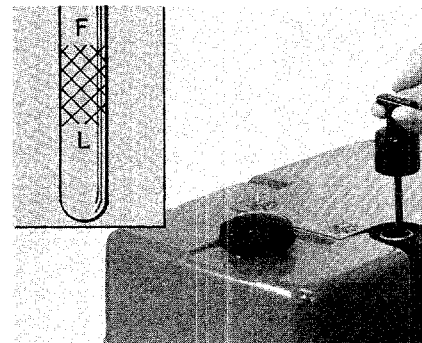

6-49: Checking oil level on 8 HP Kohler engine.

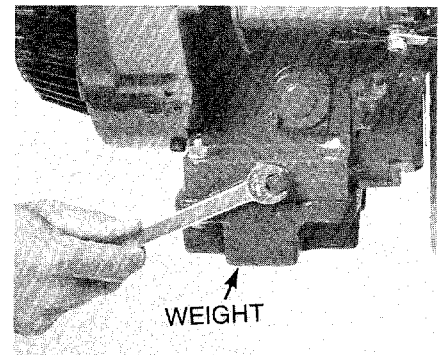

6-50: Oil drain plug on 7 HP Briggs & Stratton engine.

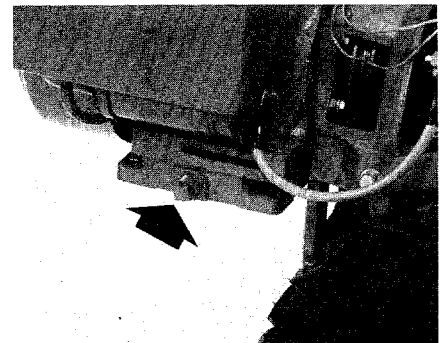

6-51: Oil drain plug on 8 HP Kohler engine.

Air cleaner maintenance

Your engine is equipped with a dual element air cleaner that filters the air twice before it reaches the carburetor. The outer foam pre-cleaner filters the air first. The inner dry paper element then filters the air a second time.

It is vitally important that both air filters be kept clean and properly installed at all times. A dirty, clogged filter can cause hard-starting, stalling, or overheating problems. An improperly installed or damaged filter can allow unfiltered air into the engine, resulting in premature engine wear and damage. Never operate the engine without both air filters installed.

Clean and re-oil the foam pre-cleaner element every 25 operating hours, or sooner if operating conditions are extremely dusty or dirty. Cleaning the element as often as every 10 operating hours should not be considered excessive.

IMPORTANT

When servicing the air cleaner, take extra precautions to prevent dirt or other debris from entering the carburetor. Clean the cover and surrounding areas carefully before removing the cover.

WARNING

To help avoid personal injury, stop the engine, remove the electric start key, disconnect the spark plug wire, and let the engine and muffler cool before inspecting or servicing the air cleaner.

After every 25 operating hours, check that the inner dry paper element is tightly secured against the mounting base. If loose, unfiltered air will bypass the element and be drawn directly into the engine.

Replace the inner dry paper element every 100 operating hours, or sooner if it is dirty or torn (inspect the element whenever the foam element is removed for cleaning). We do not recommend trying to clean a dirty paper element, as it is almost impossible to remove every trace of dirt and other harmful particles.

A. Cleaning the foam pre-cleaner

1. Remove knob (7 HP engine) or wing nut (8 HP engine) and remove air cleaner cover.
2. Gently remove the foam filter from paper element. See Photo 6-52 or 6-53.
3. Inspect foam filter and the paper element for excessive wear, damage or improper fit. Do not reuse if condition is questionable.
4. Wash the foam filter in a warm water/liquid detergent solution.
5. Rinse foam filter with clean water and squeeze (do not twist or wring) out excess water. Let filter air dry.
6. Saturate foam filter with clean, fresh engine oil and squeeze (do not twist or wring) out excess oil.
7. Reinstall foam filter over paper element, making sure foam filter completely surrounds the paper filter.
8. Clean the inside of the air filter cover and replace cover securely.

Replacing the paper element

1. Remove the air cleaner cover and foam pre-cleaner as described in Steps 1 and 2 of "Cleaning the foam pre-cleaner."
2. On the 7 HP Briggs & Stratton engine, remove the wing nut, cup, and paper element. See Photo 6-54. On the 8 HP Kohler engine, remove the hex nut, element cover, and paper element. See Photo 6-55.
3. Hold the filter up to a strong light and inspect it for cleanliness, tears or punctures. If very dirty, torn, bent or damaged, replace it with a new element.
4. Clean the base plate and the inside of the air cleaner cover, being careful not to let any dirt enter the breather hole in the base plate. Make sure the base plate is secure, and is not bent or damaged.
5. Install paper element over stud and reinstall parts removed in Step 2. Tighten the nut firmly to ensure a tight seal at the top and bottom of the paper element.

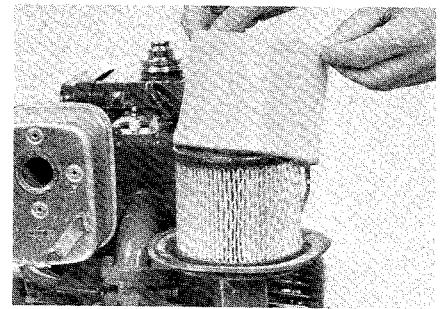

6-52: Foam filter on 7 HP engine.

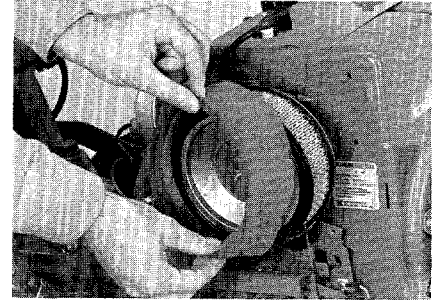

6-53: Foam filter on 8 HP engine.

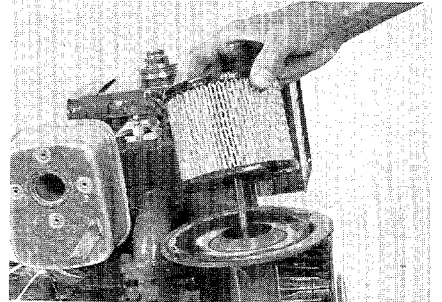

6-54: Paper filter on 7 HP engine.

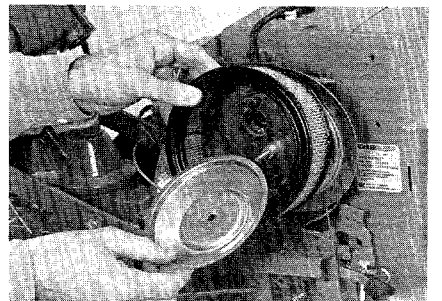

6-55: Paper filter on 8 HP engine.

6. Reinstall the foam filter (washed and oiled) over the paper element, making sure that the foam filter completely surrounds the paper filter.
7. Reinstall the air cleaner cover and secure with nut.

NOTE: When reinstalling the air cleaner cover on the 7 HP Briggs & Stratton engine, make sure that the slot in the side of the cover points inward, toward the engine.

Throttle cable adjustments

The throttle lever settings have been factory adjusted and unnecessary adjustments should not be made. However, if the engine does not start or stop, or if it does not respond immediately to various throttle lever settings, then the following adjustments may be necessary.

WARNING

To help avoid personal injury, stop the engine, remove the electric start key, disconnect the spark plug wire, and let the engine and muffler cool before adjusting the throttle cable.

A. To adjust the 7 HP Briggs & Stratton throttle cable

1. Move the throttle lever on the handlebar to the "FAST" position.
2. With the lever in the "FAST" position, the Speed Control Lever (see Photo 6-56) on the throttle control bracket should be located all the way forward in its mounting slot (see Fast Speed setting in Photo 6-56). If it is, go on to Step 4. If it isn't, proceed to Step 3.
3. Loosen (do not remove) the Cable Clamp Screw (see Photo 6-56) until the throttle cable is free to move. Then move the cable forward until the Speed Control Lever reaches the end of the slot. Tighten

the Cable Clamp Screw securely and proceed to Step 4.

4. Move the throttle lever on the handlebar to the "STOP" position. While doing so, look at the Speed Control Lever and Shut-Off Tab on your engine (see Photo 6-56). As the Speed Control Lever reaches the end of its mounting slot, the Shut-Off Tab should spring outward, away from the engine. If it does, the throttle cable is properly adjusted to stop the engine and further adjustments are not necessary. If it doesn't, proceed to Step 5.

5. Move the throttle lever on the handlebar to the "STOP" position and then loosen (do not remove) the Cable Clamp Screw until the throttle cable is free to move. Then pull the cable back until the Shut-Off Tab springs outward. Tighten the Cable Clamp Screw securely.
6. Test the operation of the throttle lever by moving it back and forth between the "FAST" and "STOP" positions. As you do, check that the Speed Control Lever on the throttle control bracket functions as described in Steps 2 and 4. If you are unable to properly adjust the cable, call or write us for further advice.

B. To adjust the 8 HP Kohler throttle cable

1. Move the throttle lever on the handlebar to the "STOP" position.

2. Loosen the Cable Clamp Screw (Photo 6-57) until the throttle cable is free to move.

3. Move the Carburetor Control Arm (Photo 6-57) to the right until it touches the Engine Shutoff Switch. Remove any slack in the throttle cable and retighten the Cable Clamp Screw.

4. Move the throttle lever on the handlebar to the "FAST" position.

5. Check that the Carburetor Control Arm (Photo 6-57) is now touching the High Speed Stop Screw. If it isn't, loosen the Cable Clamp Screw and move the Carburetor Control Arm back until it does. Then securely tighten the Cable Clamp Screw.

6. Check the operation of the throttle control lever as follows:

- (a) Move the throttle control lever on the handlebar to the "STOP" position. The Carburetor Control Arm should be touching the Shutoff Switch.
- (b) Move the throttle control lever to the "FAST" position. The Carburetor Control Arm should be touching the High Speed Stop Screw.
- (c) If the Carburetor Control Arm does not touch both the Shutoff Switch and the High Speed Stop Screw, readjust the cable settings as explained previously. If you are unable to properly adjust the cable, call or write us for further advice.

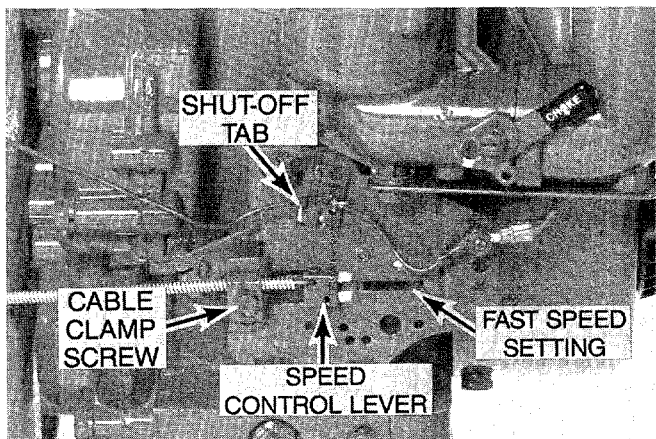

6-56: Throttle control bracket on 7 HP Briggs & Stratton Engine.

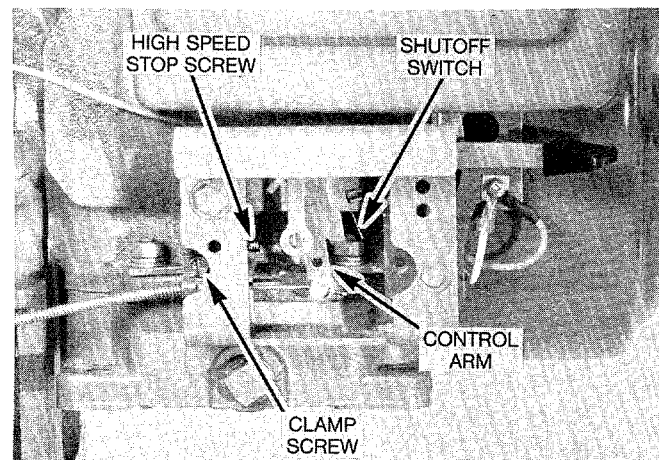

6-57: Throttle control bracket on 8 HP Kohler Engine.

Air cooling system maintenance

To ensure adequate cooling and correct engine speed, air must be able to circulate through the air intake screen, past the engine cover and over the cooling fins.

Each day before you start the engine, inspect it for any debris that could block the air flow. Use a small brush or a screwdriver wrapped in a rag to remove any trapped debris.

Never operate the engine with any of the engine shrouds or covers removed. These parts are carefully designed to direct cooling air over all points of the engine. Removing any of them could cause dangerous hot spots to develop that could lead to engine damage.

WARNING

To help avoid personal injury, stop the engine, remove the electric start key, disconnect the spark plug wire, and let the engine and muffler cool before inspecting or servicing the engine.

Ignition system maintenance

Your engine is equipped with electronic ignition. It does not have a condenser or points, and therefore you do not have to perform any regular "tune-up" maintenance on this system other than adjusting or replacing the spark plug.

Spark plug maintenance

The spark plug (see Photo 6-58 or 6-59) provides the necessary spark to ignite the fuel mixture in the engine's combustion chamber. It is essential to proper engine operation to have a plug that is properly adjusted and in good condition.

Remove and inspect the plug after every 50 operating hours or at the beginning of each year, whichever comes sooner.

See Page 71 in this Manual for replacement spark plug specifications.

Plug removal and inspection

WARNING

To help avoid personal injury, stop the engine, remove the electric start key, disconnect the spark plug wire, and let the engine and muffler cool before performing spark plug maintenance.

1. Clean the area around the spark plug before removing it to prevent dirt or debris from entering the engine.
2. Use a plug wrench or spark plug socket to remove the spark plug.
3. Inspect the spark plug:
 - (a) Use a wire feeler gauge (Photo 6-60) to check the electrode
4. Replace the plug and tighten it finger tight. Then use a torque wrench to tighten it securely (see chart below). If you don't have a torque wrench, tighten the plug firmly by hand. Then use your plug wrench to gently give it an extra $\frac{1}{4}$ turn. Do not overtighten.

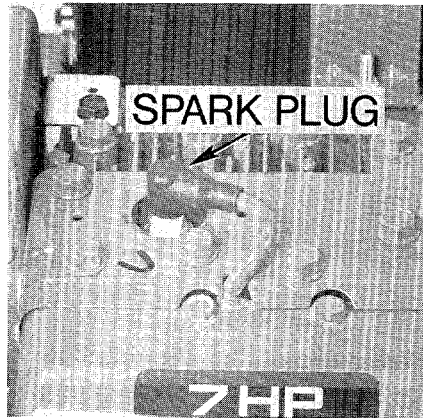

6-58: Spark plug on 7 HP Briggs & Stratton Engine.

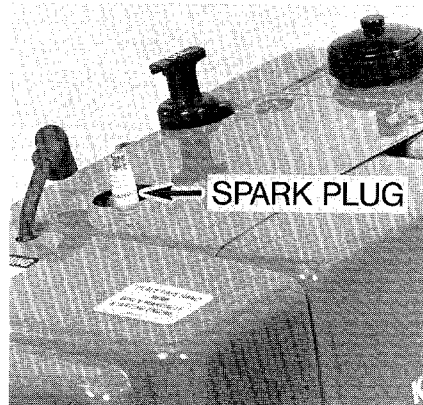

6-59: Spark plug on 8 HP Kohler Engine.

gap. On the 7 HP Briggs & Stratton Engine, the gap is .030"; on the 8 HP Kohler Engine, the gap is .025".

- (b) Check the porcelain. If cracked, do not reuse the plug.
 - (c) Check the electrodes. If pitted or burned, do not reuse the plug. If the electrodes show only moderate wear, clean carefully by scraping (do not wire brush or sand blast). Be sure entire spark plug is clean before replacing.
 - (d) A spark plug showing a light coating of gray or tan deposits and slight electrode wear indicates normal engine operation. If the plug is wet with oil, or has heavy black or blistered white deposits, take it to an authorized engine service dealer for analysis.
4. Replace the plug and tighten it finger tight. Then use a torque wrench to tighten it securely (see chart below). If you don't have a torque wrench, tighten the plug firmly by hand. Then use your plug wrench to gently give it an extra $\frac{1}{4}$ turn. Do not overtighten.

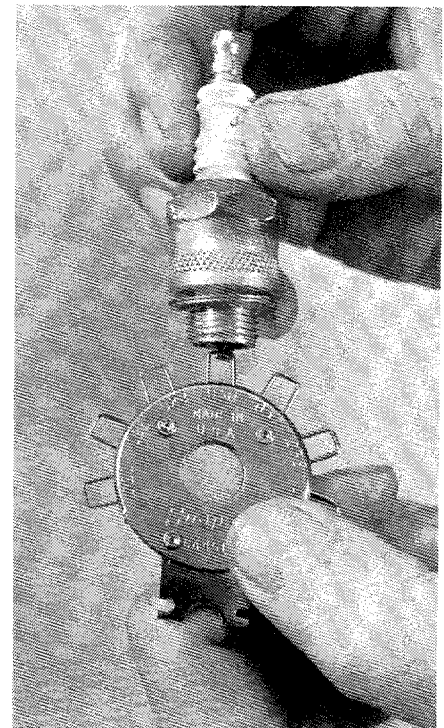

6-60: Checking electrode gap.

Carburetor adjustments

The carburetor provides the engine's combustion chamber with the correct air-fuel ratio for a wide range of operating conditions.

The factory settings should be correct for average operating conditions and you should avoid making unnecessary adjustments. However, if you feel that an adjustment is needed to compensate for differences in fuel, temperature, altitude or load, please refer to the following recommended adjustments.

WARNING

Keep cigarettes, sparks, and open flames away from the carburetor and fuel system to prevent the possibility of a fire or explosion.

IMPORTANT

The carburetor adjusting screws are needle valves which taper to critical dimensions. These screws can be damaged if they are turned in forcefully.

WARNING

Do not operate the engine in an enclosed or poorly ventilated area. Engine exhaust gases contain carbon monoxide, an odorless, tasteless, and deadly poison.

7 HP Briggs & Stratton:

1. With the engine stopped, gently turn the High Speed Needle Valve and Throttle Idle Mixture Valve clockwise until they just close. The valves may be damaged by turning them too far. See Figure 6-61.
2. Now open High Speed Needle Valve 1½ turns counterclockwise and Throttle Idle Mixture Valve one turn counterclockwise. This initial adjustment will permit the engine to be started.
3. Start engine and allow to warm for a few minutes prior to final adjustment. NOTE: The air cleaner must be assembled to carburetor when running the engine.

4. Place the throttle lever on the handlebar in the "FAST" position. Turn the High Speed Needle Valve clockwise until engine slows (lean mixture). Then turn it out past the smooth operation point (rich mixture). Now turn the needle valve to a midpoint setting between rich and lean.
5. Adjust the idle RPM as follows:
 - (a) Rotate the throttle counterclockwise and hold it against the Throttle Stop while adjusting the Throttle Idle Speed Adjusting Screw to obtain 1750 RPM. Turn screw in for faster idle; out for slower idle.
 - (b) While still holding throttle against Throttle Stop, turn Throttle Idle Mixture Valve in (lean) and out (rich). Set valve at midpoint between rich and lean. Release throttle. If engine will not accelerate properly, the carburetor should be readjusted, usually to a slightly richer mixture.

8 HP Kohler:

1. With the engine stopped, turn the Main Fuel and Idle Fuel adjusting screws clockwise, until they bottom lightly (Photo 6-62).
2. Preliminary Setting—Main Fuel Screw: Turn the Main Fuel Screw out 2 full turns from bottom.
3. Preliminary Setting—Idle Fuel Screw: Turn the Idle Fuel Screw out 1¼ turns from bottom.
4. Final Setting—Main Fuel Screw: Place the Wheels/Tine/PTO Drive Lever in "NEUTRAL" and start the engine. Let it run at half-throttle speed for 5-10 minutes. Move the throttle lever to the "FAST" position and then turn the Main Fuel Screw clockwise until the engine starts to lose speed (too lean a mixture). Now, count the turns as you turn the screw counterclockwise until the engine begins to run unevenly (too rich a mixture). Turn the screw clockwise to a point midway between the too lean and too rich mixtures. That position, or turning the screw counterclock-

wise about ½ turn more, should be the proper setting for tilling.

5. Final Setting—Idle Fuel Screw: Place the Wheels/Tine/PTO Drive Lever in "NEUTRAL" and start the engine. Let it run at half-throttle speed for 5-10 minutes. Allow the engine speed to fall to idle, or put the engine throttle in the idle position. Adjust the Idle Fuel Screw by following the same procedure described in Step 4. The recommended idle speed should not exceed 1500 RPM (Revolutions Per Minute)*
6. Idle Speed Setting: Place the Wheels/Tine/PTO Drive Lever in "NEUTRAL" and start the engine. Let it run at half-throttle for 5-10 minutes. Allow the engine speed to fall to idle, or put the engine throttle in the idle position. Adjust the engine idle speed to the desired RPM* by turning the Idle Speed Screw clockwise or counterclockwise. Allow several seconds between each adjustment for the engine to adapt to each new setting.

*Typical idle speed is 1200 RPM.

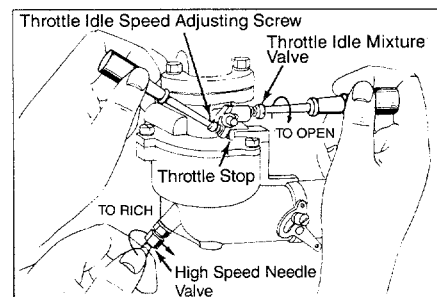

6-61: 7 HP Briggs & Stratton Engine carburetor.

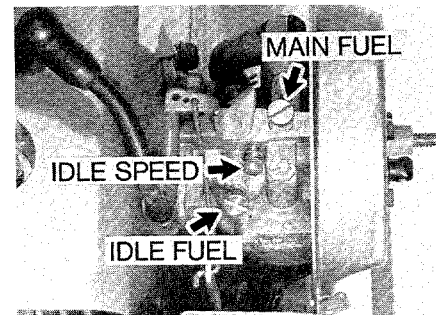

6-62: 8 HP Kohler Engine carburetor (air cleaner components removed for photo clarity).

Battery care and maintenance

The following guidelines will help to protect your battery while it is in service during seasonal use and during extended periods of storage. To ensure maximum battery life and performance, these guidelines should be followed carefully.

DANGER

POISON—CAUSES SEVERE BURNS

- Electrolyte is a sulfuric acid solution.
- Avoid contact with skin, eyes and clothing.
- To prevent accidents, wear protective clothing, rubber gloves, and shield eyes with safety goggles.
- Neutralize acid spills with baking soda and water solution. Neutralize empty container with baking soda and rinse with water.

ANTIDOTE: External—Flush with water. Eyes—Flush with water for 15 minutes and get prompt medical attention.

ANTIDOTE: Internal—Drink large quantities of water or milk. Follow with milk of magnesia, beaten eggs, or vegetable oil. Call physician immediately.

KEEP OUT OF REACH OF CHILDREN

DANGER—BATTERIES PRODUCE EXPLOSIVE GASES

- Keep sparks, flame, cigarettes away.
- Ventilate area when charging or using battery in an enclosed space.
- Make sure venting path (vent tube) of battery is always open.

DANGER

Never touch the positive (+) battery post and any other surrounding metal with tools, jewelry, or other metal objects. Doing so can cause a short circuit that could result in electrical burns, an electrical shock, or an explosion of battery gases.

A. Battery care in service

1. Once a month or every 10 operating hours, whichever occurs first, check the level of the electrolyte:
 - (a) If the battery has “UPPER” and “LOWER” level lines marked on one side of its case, the electrolyte level should be at the “UPPER” level line. (Be sure battery is level when checking the electrolyte level.)
 - (b) If the battery does not have “UPPER” and “LOWER” level lines marked on one side of its case, the electrolyte level should just touch the lowest part of the filler well in each cell. See Figure 6-63. (Be sure battery is level when checking the electrolyte level.)

If necessary, use distilled or demineralized water (DO NOT USE BATTERY ACID) to refill each cell to the proper level. After filling, replace the battery caps and wash off any spilled electrolyte with a baking soda and water solution. Next, run the engine outdoors for about 20 minutes at $\frac{3}{4}$ throttle speed to help recharge and recirculate the electrolyte solution. For safety, do not leave the tiller unattended while the engine is running.

2. Keep the battery clean. If the terminals are corroded, remove the battery and clean the terminals with a wire brush, sandpaper, or steel wool. AVOID GETTING THE CORROSIVE MATERIAL (WHICH IS ACID OXIDATION) ON YOUR SKIN OR IN YOUR EYES. Then rinse the battery with a baking soda and water solution (be sure the battery caps are securely tightened before rinsing). Coat the terminals with petroleum jelly or silicone grease to prevent further corrosion.
3. Periodically check the entire electrical system for loose or dirty connections.
4. Periodically check that the battery clamp is tight enough to keep the battery firmly in place. Do not overtighten the clamp as it could damage the battery case or clamp.
5. Periodically check that the vent tube is not crimped or pinched anywhere along its length.

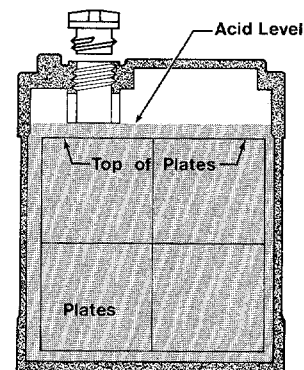

6-63: Keep battery filled to bottom of filler wells.

WARNING

To help avoid personal injury, make certain that the battery vent tube is not crimped, pinched, or folded anywhere along its length. Improper venting could result in a battery explosion.

B. Battery care in storage

Your engine has a recharging circuit that will properly maintain the battery's state of charge during the normal tilling season. When the tiller will not be used for an extended period of time, we recommend that the battery be fully charged before placing it in storage. Before reinstalling the battery after storage, it should again be given a thorough recharge.

1. Remove the battery from the tiller (see “Battery Removal” in instructions) and place it on a level surface.

DANGER

- While the battery is being charged, do not leave it unattended. The charging time does not have to be continuous.
- Carefully follow all charging instructions and safety rules provided by the manufacturer of the charging equipment.
- Never attempt to “jump start” the battery with an automobile battery or its charging system. Doing so could result in serious personal injury or property damage from such causes as a battery explosion, or acid or electrical burns.

2. Clean the battery, if needed. If the battery is extremely cold, allow it to warm to between 60°F–80°F.

3. Remove all filler caps. Leave caps off while filling and charging.

4. Carefully check the electrolyte level. If, and only if, the electrolyte level is low, add distilled or demineralized water (DO NOT USE BATTERY ACID) to adjust the electrolyte level to the correct height (see "A. Battery care in service" on page 56 for filling instructions. Avoid overfilling.

5. Charge the battery until all of the cells are gassing freely. (To check for gassing, WEAR SAFETY GOGGLES and use a flashlight to look down into each cell while the battery is being charged. When gassing freely, the surface of the liquid electrolyte should be covered with tiny bubbles). Use one of the following procedures:

(a) Recommended Method:

Charge the battery at a rate of 1 to 2 amperes until all cells are gassing freely. The total charging time should not exceed 24 hours.

(b) First Alternative:

Charge the battery at a rate of 4 to 6 amperes until all cells are gassing freely. The total charging time should not exceed 8 hours.

(c) Second Alternative:

Charge the battery at a rate of 6 to 12 amperes until all cells are gassing freely. The total charging time should not exceed 4 hours.

CAUTION

Do not charge the battery at a rate higher than 12 amperes. A charge rate of more than 12 amperes generates excessive heat and gassing and will permanently damage the battery.

6. When the battery is fully charged, turn off the charging equipment and then disconnect the cables. Check the electrolyte

level in each cell. If necessary, add distilled or demineralized water (DO NOT ADD BATTERY ACID) to adjust the electrolyte level to the correct height. Then reconnect the charger cables to the battery and charge the battery for an additional one hour.

7. Replace the filler caps and wash off any spilled electrolyte with a baking soda and water solution.

8. Store the battery in a cool, dry place away from heat ducts, radiators, and direct sunlight. Avoid freezing temperatures. A battery loses voltage in storage, more so in hot weather than in cold. An ideal storage temperature is 50°F.

C. Battery removal and replacement

WARNING

To help avoid personal injury, stop the engine, remove the electric start key, disconnect the spark plug wire, and let the engine and muffler cool before removing or replacing the battery.

1. Disconnect the negative (–) cable from the grounding screw located on the right side of the battery bracket ("A" in Photo 6-64)

and bend the cable safely away from any metal parts.

2. Disconnect the negative (–) cable from the negative battery post ("B" in Photo 6-64) and remove the cable.

3. Disconnect the positive (+) cable from the positive battery post ("C" in Photo 6-64) and bend it safely away from any metal parts. Cover the cable terminal with the rubber boot.

4. Remove the battery hold-down clamp and remove the battery.

5. Reverse the previous steps when replacing the battery. Be very careful that you place the battery on the bracket so that its posts are facing to the rear (tine end) of the tiller. The positive (+) post must be on the left side as you face forward from the handlebars.

6. Insert the vent tube (on positive (+) side of battery) into the vent tube shield. Be sure that the tube is not crimped, pinched, or folded anywhere along its length.

WARNING

When removing the battery, always disconnect the negative (–) cable first, followed by the positive (+) cable. Reverse this procedure when reinstalling the battery.

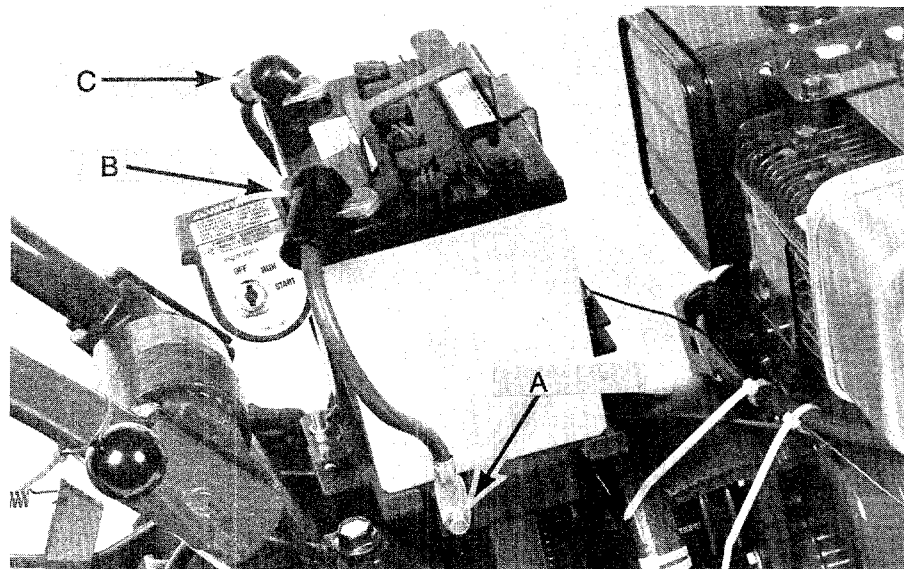

6-64: Follow removal and replacement instructions carefully.

Troubleshooting the electric start system

WARNING

Before troubleshooting the electric start system, place the Wheels/Tines/PTO Drive Lever in "NEUTRAL" and disconnect the spark plug wire from the spark plug.

Here are some simple checks you can make to troubleshoot the electric start system. If these checks do not isolate the problem, please call our Technical Service Department for further advice.

If the starter motor doesn't turn over

If the starter motor doesn't turn over when you turn the key switch to the "START" position it could be due to one or more of the following causes:

1. Loose, broken or corroded wires or cables.
2. A faulty solenoid, or discharged battery.
3. A faulty starter motor.
4. A faulty wiring harness and/or key switch.

1. Check all wires and cables

- A.** Make sure that all connections are tight.
- B.** Check for rust or paint that would prevent good electrical contact at all connections.
- C.** Make sure that the insulation on all wires and cables is in good condition and that a break in the insulation is not allowing a bare wire to touch any metal surfaces.
- D.** After completing Steps A through C, try to start the engine. If it starts, you have corrected the problem. If it doesn't start, proceed to the next step.

2. Check for faulty solenoid

- A.** You will need a jumper wire for the following steps. Make one by stripping about 3/4-inches of insu-

lation from both ends of a 12-inch length of heavy (#10 or heavier) insulated wire. Hold only the insulated part of the wire when performing the following steps.

B. Make sure that the Wheels/Tines/PTO Drive Lever is in "NEUTRAL".

C. Replace the negative (-) battery cable with the jumper wire as follows:

- (a) Disconnect the negative (-) cable from the grounding screw on the right side of the battery bracket and bend the cable terminal safely away from any metal parts.
- (b) Disconnect the upper end of the cable from the negative (-) battery post and remove the cable.
- (c) Connect one end of the jumper wire to the negative (-) battery post, being careful not to allow the other end of the wire to contact any metal parts.
- (d) Connect the loose end of the jumper wire to the grounding screw on the battery bracket. See Photo 6-65.

IMPORTANT

When removing the jumper wire and replacing it with the negative (-) battery cable, follow the procedure given in Step 2-C above.

- D.** Using the battery cable as a jumper wire, touch one end of the cable to the solenoid terminal that is marked "B" in Sketch 6-66 or 6-67.
- E.** BRIEFLY touch the other end of the cable to the solenoid terminal that is marked "C" in Sketch 6-66 or 6-67. There may be a spark when you do this. If the starter motor turns over, the solenoid is in good condition. If the starter motor didn't turn over, the solenoid may be bad. First check to make sure that the screws which attach the solenoid to the battery bracket are tight. After tightening the screws,

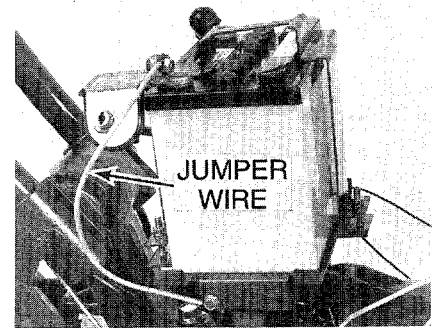

6-65: Replace negative (-) battery cable with #10 insulated jumper wire.

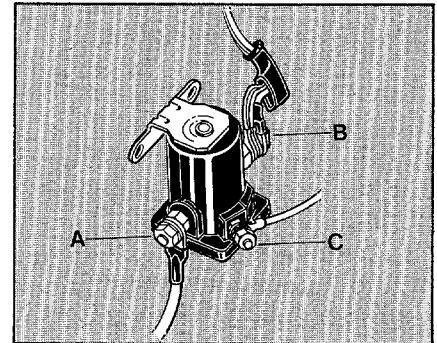

6-66: Earlier style solenoid is shown above.

repeat this Step. If the starter motor still doesn't turn over, please call our Technical Service Department for further advice.

F. If there was no spark when you jumped the solenoid, it indicates that the battery will not hold a charge. You should charge the battery (see page 56) or take the battery to a qualified battery technician for testing and charging.

3. Check for faulty starter motor

- A.** You will again use the negative (-) battery cable as a jumper wire.
- B.** Make sure that the Wheels/Tines/PTO Drive Lever is in "NEUTRAL".

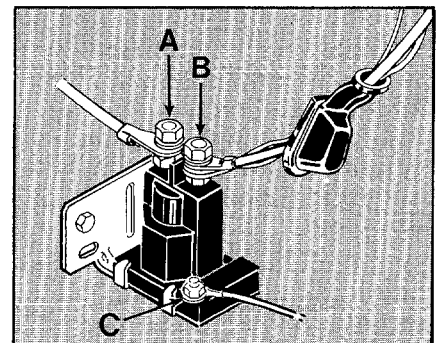

6-67: Later style solenoid is shown above.

C. Touch one end of the battery cable to the solenoid terminal that is marked "B" in Sketch 6-66 or 6-67.

D. BRIEFLY touch the other end of the cable to the solenoid terminal that is marked "A" in Sketch 6-66 or 6-67. This brief touch will likely cause a spark and should also energize the starter motor.

E. If the starter motor turns over, it means that the starter motor is working. If there was a spark, but the starter motor didn't turn over, then the starter motor may be at fault. Call our Technical Service Department for further advice.

4. Check for faulty wire harness and key switch

A. If you haven't done so already, reinstall the negative (-) battery

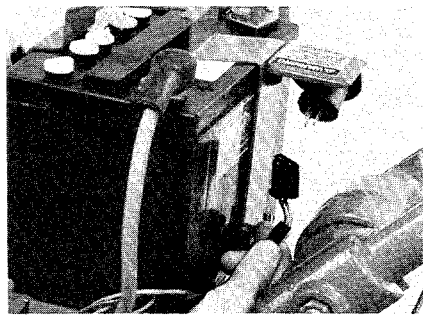

6-68: Unplug receptacle from key switch.



6-69: Use jumper wire to "jump" key switch wires.

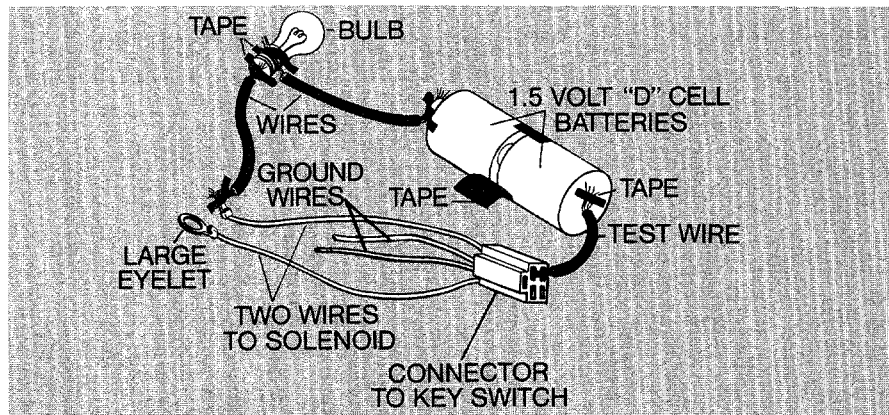

6-70: First test red wire with small eyelet, then red wire with large eyelet. Proper continuity should light the bulb.

cable that you removed in Step 2-C of these instructions. Then use the insulated #10 wire as your jumper wire in the following steps.

B. Make sure that the Wheels/Tines/PTO Drive Lever is in "NEUTRAL".

C. Unplug the wire harness receptacle from the back of the key switch (Photo 6-68). Clean any corrosion out of the five sockets on the receptacle. Next clean any corrosion off the tabs on the back of the key switch. Reconnect the receptacle to the key switch and try to start the engine with the key. If it starts, you have corrected the problem. If it doesn't start, proceed to the following steps.

D. Insert the ends of the #10 jumper wire into the two sockets on the receptacle that have the red wires going to them (Photo 6-69). If the starter motor turns over when you do this, then the problem is with the key switch. If it doesn't turn over, then the problem could be a faulty wire harness or a faulty key switch.

E. To test the key switch and the wire harness, you will need a continuity tester. If you don't have one, you can make one from two "D" cell flashlight batteries, a

flashlight bulb, some wire and some tape. Refer to Figure 6-70 to see how to make one.

F. To test the wiring harness:

- (a) Unplug the receptacle from the back of the key switch.
- (b) Disconnect the negative (-) battery cable from the grounding screw on the right side of the battery bracket and bend the cable terminal safely away from any metal parts.
- (c) Test each of the two red wires for continuity by placing the ends of the continuity tester wires at both ends of a single wire (see Figure 6-70). If the lamp lights, electricity is flowing through the wire and it is okay. Repeat this step for the other red wire. Let us know if a wire doesn't light the bulb.
- (d) After testing both red wires, reconnect the negative (-) battery cable to the grounding screw on the battery bracket.

G. If the red wires in the wiring harness are okay, you may have either a faulty keyswitch or a bad ground. Call our Technical Service Department for further advice.

If the key switch doesn't shut off the engine

There are two ways to stop the engine on your electric start tiller:

1. Move the throttle lever on the handlebar to the "STOP" position.
2. Turn the key switch to the "OFF" position.

Both methods stop the engine by grounding out the ignition system. If the key switch doesn't work, here's what to do:

A. Inspect the green wire that leads from the key switch receptacle to the plastic terminals shown in Photo 6-72. Push these terminals together to ensure a good connection. Now test if the engine will stop when the key switch is moved to the "OFF" position. If the engine doesn't stop, proceed to the next step.

B. While the engine is running, unplug the receptacle from the back of the key switch.

C. Place one end of a jumper wire (#10 or heavier insulated wire) into the receptacle socket that the green wire goes into. Touch the other end to the mounting screw at the front of the battery hold-down clamp (Photo 6-73). If the engine stops, then the key switch is faulty. If it doesn't stop, then you may have a break somewhere in the green wire (call us if you suspect this is the problem).

D. To check the key switch, remove it from its mounting bracket with large pliers or a $\frac{7}{8}$ -inch wrench. To shut the engine off, the washer underneath the nut must be contacting bare metal. If the key switch decal is blocking that metal-to-metal contact, scrape some of the decal away so that good contact is made. Reinstall the switch and check it to make sure that it will now shut the engine off. If the switch still doesn't work, contact us for further advice.

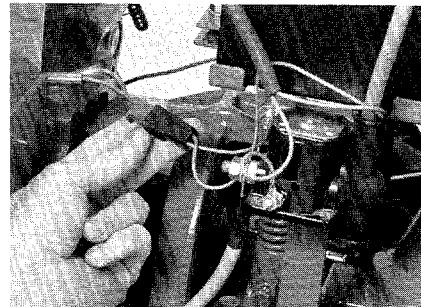

6-72: Make sure plastic terminals are connected securely.

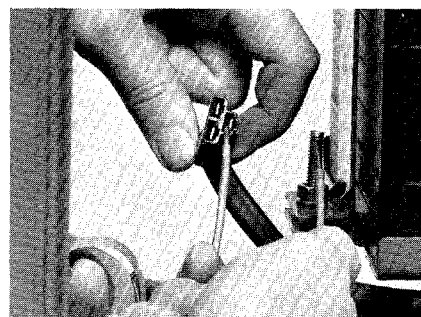

6-73: Run jumper wire from single hole (for green wire) in receptacle to screw that secures hold-down clamp to battery bracket.

Storing your tiller

When your tiller won't be used for a long period of time, you should protect it from deterioration by following these simple steps.

1. Clean the tiller and the engine.
2. Perform routine tiller lubrication and check for loose bolts and nuts.
3. Run the engine until all of the gasoline is used up. Avoid leaving gasoline in the fuel tank for long periods of time as it can form gum deposits that will foul the carburetor and fuel lines.
4. While the engine is still warm, drain the engine crankcase oil. Refill with fresh oil.
5. To protect the engine's cylinder against rust, remove the spark plug

and pour one ounce of clean engine oil into the spark plug hole. Pull the recoil rope slowly 2 or 3 times to distribute the oil (avoid oil spray from the spark plug hole when cranking the engine over slowly) and then replace the plug. Do not reconnect the spark plug wire to the plug. Now, slowly pull the rope until you feel resistance; then let it rewind. At this point, the valves are seated, which will help to prevent rust from forming in the cylinder or the valve seats.

6. Charge the battery on electric start models and store it in a cool, dry place.
7. Place the Wheels/Tines/PTO

Drive Lever in "NEUTRAL" and store the tiller in a clean, dry place.

8. Never store machine with fuel in the fuel tank inside a building where fumes may reach an open flame or spark, or where ignition sources are present (such as hot water and space heaters, furnaces, clothes dryers, stoves, electric motors, etc.)
9. Remember—this is a good time to order replacement parts for the next tilling season.

Inspect Forward Interlock Wiring System

Every 10 operating hours you should check the Forward Interlock wiring system to make sure that all connections are tight, and that a break in the insulation is not allowing a bare wire to touch any metal surfaces.

1. Check the insulated wire harness that leads from the lower ends

of the handlebars over to the wire harness connector on the top, right side of the transmission cover (see Photo 6-76). Next check that the connector is securely mated.

2. Check the insulated tubing that leads from the connector over to the cast iron motor mount/belt shroud. Check the wire that leads

from the tubing over to the switch assembly mounted on top of the tab on the cast iron motor mount/belt shroud (see Photo 6-74). Then check the second wire that leads to the throttle cable mounting bracket on the right side, forward portion of the engine.

Troubleshooting the Forward Interlock Safety System

The wiring circuit for the Forward Interlock Safety System is designed to ground out the engine's ignition system, much like a spark plug shutoff clip found on many small engines.

There are three switches in the circuit which, when open, allow the engine to run. One switch is located on the neutral plunger tab of the cast iron motor mount (see Photo 6-74). This switch is opened whenever the Wheels/Tines/PTO Drive Lever is in the "NEUTRAL" or "REVERSE" positions.

The other two switches are located inside the handlebars, directly above the two Forward Interlock Levers (see Photo 6-75). The

switches are wired in series so that when either one is opened (by squeezing one of the Forward Interlock Levers), the engine will run.

There is a fourth switch that is located in the wiring harness connector on the top, right side of the transmission cover (see Photo 6-76). This switch warns you if the connection is not mated by not allowing the engine to run while the Wheels/Tines/PTO Drive Lever is in "FORWARD".

There are only a few things that could go wrong with a simple circuit such as this:

1. A broken or disconnected wire could create an open circuit and allow the engine to run without

your having to squeeze one of the Forward Interlock Levers.

2. A bare wire that touches any part of the tiller or engine could ground out the engine's ignition, regardless of the position of the switches. This, of course, would prevent the engine from running.

3. A switch that has failed internally or that is not being actuated mechanically may act as an open switch and allow the engine to run. Or, it may act as a ground and prevent the engine from running.

Please refer to the troubleshooting chart on page 62 if your system is not operating correctly.

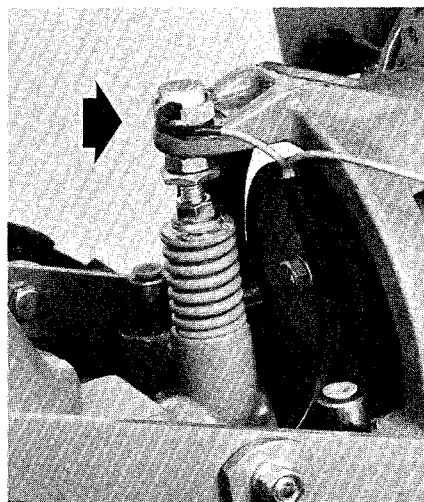

6-74: Neutral plunger switch.

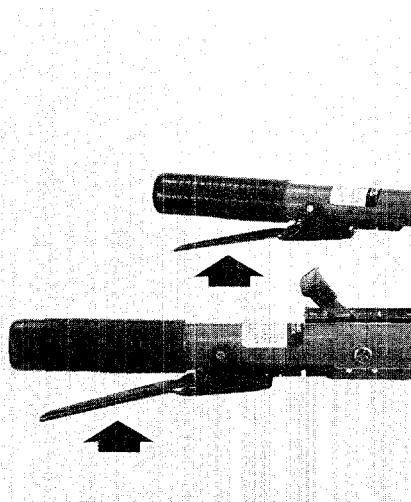

6-75: Forward interlock levers.

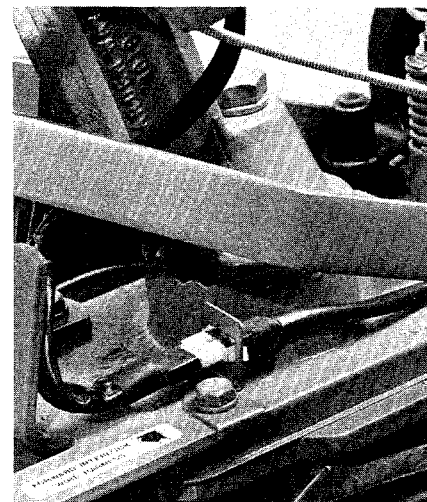

6-76: Wiring harness connector.

CHECK OR TEST

(Check or test in sequence shown until problem is resolved.)

	PROBLEM			
	Engine won't start	Engine shuts off when Wheels/Tines/PTO Drive Lever is shifted into "FORWARD"	Engine does not shut off when Forward Interlock Levers are released while Wheels/Tines/PTO Drive Lever is in "FORWARD"	Refer to Page
Throttle lever in "START" position	X			14
Wheels/Tines/PTO Drive Lever in "NEUTRAL" position	X			9
Forward Interlock Wire Harness connector securely mated		X	X	61
Forward Interlock Levers not being squeezed prior to shifting Wheels/Tines/PTO Drive Lever to "FORWARD" position		X		10
Visually inspect for bare, broken or disconnected wires	X		X	61
Check handlebar wire harness	X		X	62
Check transmission wire harness	X		X	63

each of the Forward Interlock Levers, one at a time. The bulb should go out as either lever is squeezed.

If the bulb did not glow during this test, it indicates a possible broken wire, or a wire that has pulled loose from one of the switches in the handlebars.

3. Remove one switch at a time (see "Switch Removal" instructions further on), and check the two wires on each switch for a tight connection. (The wires may be attached to either terminal on the switch. However, the longer (red) wire should be attached to the top of the switch.) After checking the connections, check for continuity between the two terminal holes in the interlock plug as described in Step 2 above. When making this test, the tiny switch plunger (shown in Photo 6-78) on both switches must be depressed either with your finger or by the interlock lever.

4. If the bulb still doesn't glow, you should remove the wires from the switch. Then touch the leads from your tester to the two terminals on the switch and press the tiny switch plunger (see Photo 6-78).

Checking the Handlebar Wiring Harness

The purpose of this test is to see that there is a continuous circuit between the terminals on the handlebar wiring harness interlock plug and the switches and wires inside the handlebars.

1. To perform this test you will need a continuity meter (volt-ohm

multitester) or a simple battery-powered continuity tester, such as the one shown on page 59 of this Manual.

2. After unplugging the wiring harness connector, place the leads from your tester into the two terminal holes in the interlock plug (see Photo 6-77). The tester bulb should glow. Now momentarily squeeze

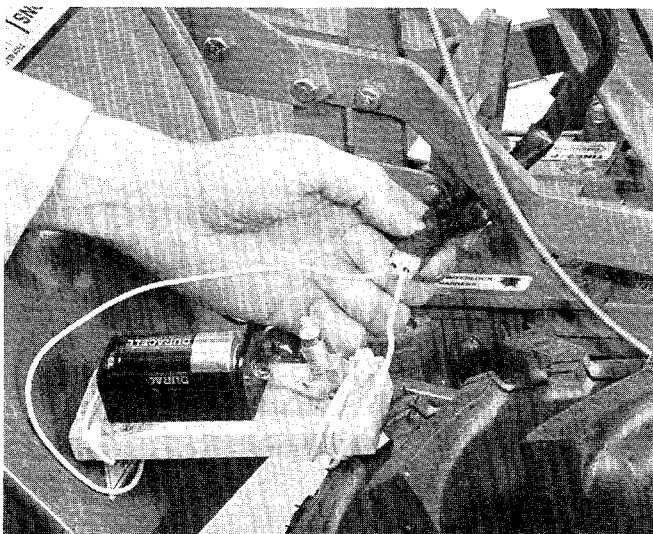

6-77: Test continuity between terminals.

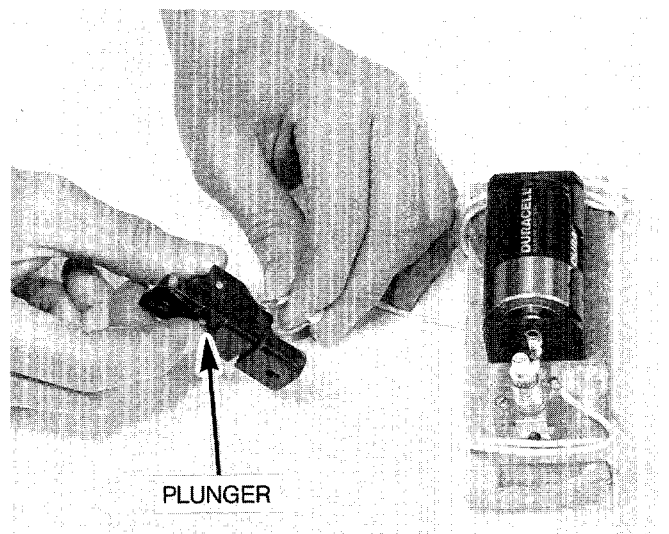

6-78: Test switch terminals while depressing switch plunger.

The bulb should glow when the plunger is depressed. If it doesn't, the switch is bad and it should be replaced.

5. While the connector is still apart, check from each terminal hole to any bare metal on the handlebar (see Photo 6-79). The bulb should not glow. If it does, there is a short to ground either from a bare wire or from a wire that has pulled free of the switch and is touching metal.

If this test indicates an open circuit or a short to ground, replace the handlebar wire harness.



6-79: Test from each terminal hole to bare metal on handlebar.

Removing the Forward Interlock Lever Switch

1. Remove the E-ring from the lever mounting shaft (see Photo 6-80). As you remove the E-ring, cup your hand around it so you don't lose it (it may fly off due to spring tension).

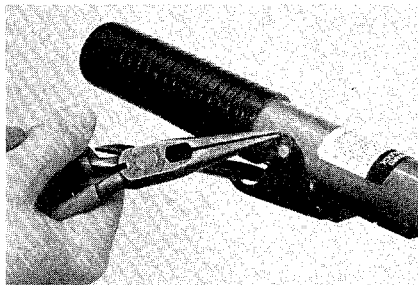

6-80: Remove E-ring.

2. Remove the mounting shaft and the lever (see Photo 6-81).

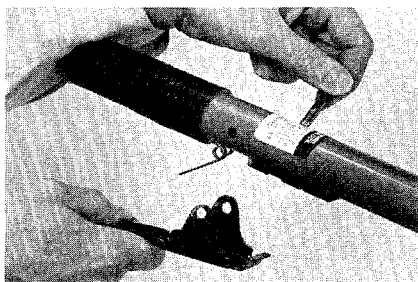

6-81: Remove shaft and lever.

3. Remove the screw in the bottom of the switch and remove the switch (see Photo 6-82).

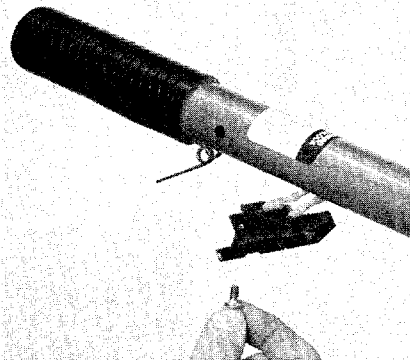

6-82: Remove screw and switch.

Checking the Transmission Wiring Harness

1. To perform this test you will need a continuity meter (volt-ohm multimeter) or a simple battery-powered continuity tester such as the one shown on page 59 of this Manual.

2. Unplug the wiring harness connector located on the top, right side of the transmission cover.

3. Remove the red transmission harness wire from the engine (see Photos 6-83 or 6-84). This is the wire that leads back to the con-

ductor. Replace the other wire on the engine terminal, tightening the screw securely. Make certain that the transmission harness wire doesn't touch any metal for the remainder of this test.

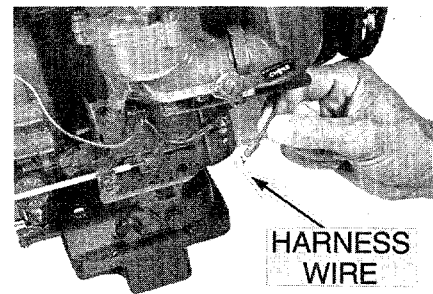

6-83: Remove red harness wire from 7HP Briggs & Stratton engine.

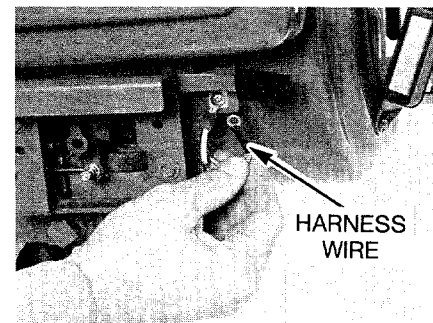

6-84: Remove red harness wire from 8HP Kohler engine.

4. Place the Wheels/Tines/PTO Drive Lever in "NEUTRAL".

5. Place one lead from your tester on the outboard connector pin and place the other lead on the terminal of the wire that you just disconnected from the engine (see Photo 6-85). The tester bulb should glow. If it doesn't, replace the transmission wiring harness.

NOTE: The harness includes the connector half and the prewired neutral switch.

6. Place the Wheels/Tines/PTO Drive Lever in the "FORWARD" position.

7. Test from the inboard pin to any bare metal on the transmission (see NOTE below). The bulb should glow. If it doesn't, remove the neutral switch (see "Removing Neutral Switch") and check the surfaces between the switch and the motor mount. It should be clean and free of paint or corrosion. Re-install the switch after completing this inspection and test the inboard pin again.

NOTE: Do not ground the test wire to the rotating washer as shown in Photo 6-86 (oil on the inside edge of the washer may interfere with the electrical current). Instead, find another spot of bare metal on the top or side of the transmission to use as a ground.

Removing the Neutral Switch

1. Place the Wheels/Tines/PTO Drive Lever in "FORWARD".

2. Hold the top half of the switch with a $\frac{7}{8}$ " wrench and loosen the hex nut underneath with an $\frac{11}{16}$ " wrench. (See Photo 6-87).

3. Remove the hex nut and external-tooth lockwasher and lift the switch out from the top of the motor mount.

4. The surfaces between the switch and the motor mount serve as an electrical ground. Make certain that the surfaces are clean and free of any paint or corrosion.

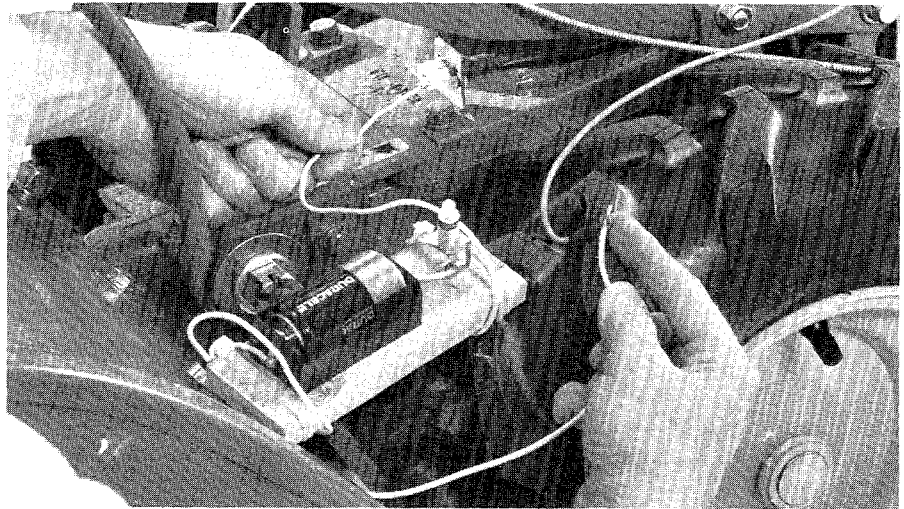

6-85: Test outboard pin to engine wire terminal.

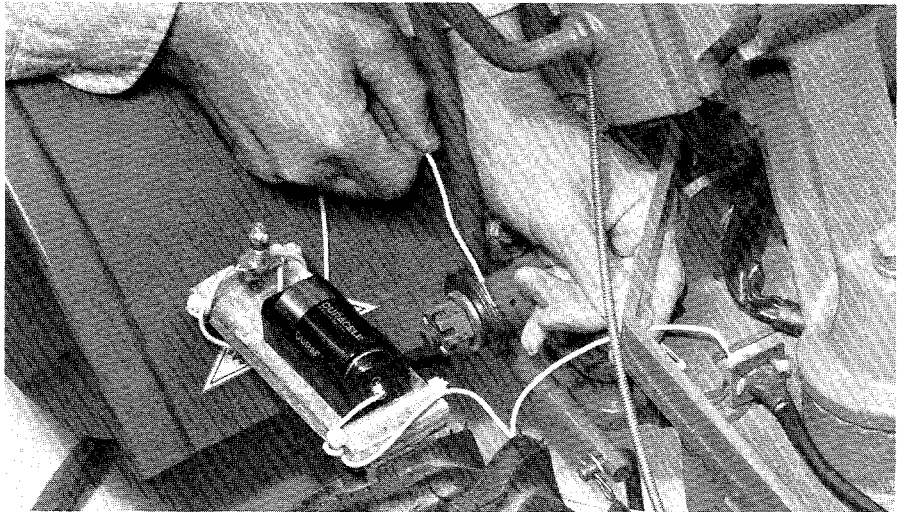

6-86: Test inboard pin to bare metal on transmission (do not use washer shown in photo).

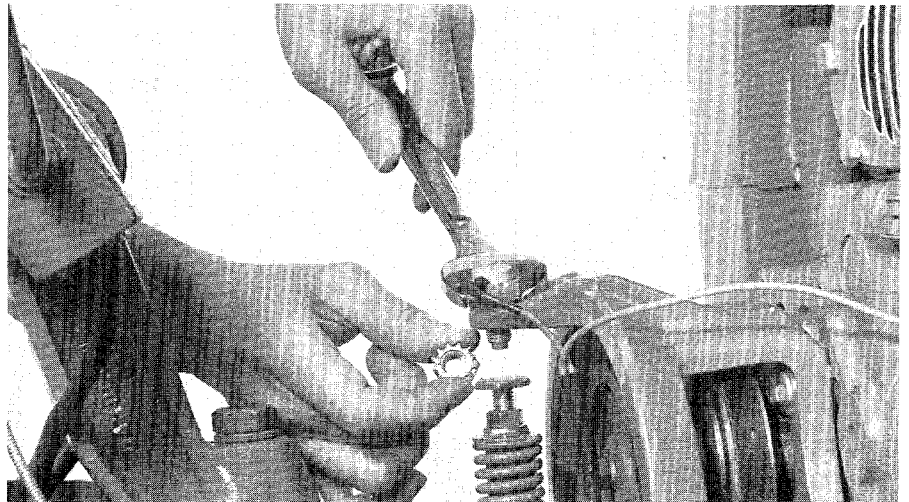

6-87: Hold top of switch and loosen hex nut below.

SECTION 7: Troubleshooting

The following pages list possible problems that you might encounter with your tiller or engine. If you don't find a particular problem here, or if you don't understand the possible solutions, please let us know so that we can help you.

Please note that the possible

causes and solutions for each problem are not necessarily listed according to their frequency of occurrence. In other words, the cause or the solution to your problem may be the first, or the last item given for each problem.

WARNING

To help avoid personal injury, stop the engine, remove the electric start key, disconnect the spark plug wire, and let the engine and muffler cool before performing any troubleshooting checks or maintenance.

PROBLEM	WHAT TO DO AND REFERENCE
---------	--------------------------

1. WHEELS/TINES/PTO DRIVE LEVER: A. Lever does not stay in "FORWARD".

- Drive belt may be too tight. Raise belt adjustment block a little. See Section 6.
- Clutch pawl spring at end of lever may be overstretched. Install new spring.

B. Lever hard to shift into "REVERSE".

- Check reverse disc for wear. See Section 6.
- Check adjustment of reverse disc and/or reverse spring and plunger assembly. See Section 6.
- Clean and re-lubricate motor mount bars, belt adjustment block and linkages on lever. See Section 6.

C. Tiller stays in "REVERSE" when lever is released.

- Lubricate motor mount bars, belt adjustment block and linkages on lever. See Section 6.
- Check adjustment of reverse spring and plunger. See Section 6. If problem continues, contact Technical Service Department.

D. Lever sticks in "FORWARD".

- Lubricate motor mount bars, belt adjustment block and linkages on lever. See Section 6. If problem continues, contact Technical Service Department.

E. Lever hard to shift into "FORWARD".

- Follow advice for Problem 1-D. Also check for possible bent motor mount bar that could be binding in engine mount holes.

PROBLEM	WHAT TO DO AND REFERENCE
---------	--------------------------

2. WHEEL SPEED LEVER: A. Lever hard to shift, or sticks in "FAST" or "SLOW" wheel gear positions.

- Lubricate eccentric lever at rear of power unit transmission. See Photo 7-1. If rust is present, use penetrating oil and work eccentric lever back and forth by hand.
- Lubricate linkage that connects Wheel Speed Lever to eccentric lever. See Photo 7-1.
- Clutch inside transmission may be binding. Disconnect linkage from eccentric lever and work eccentric lever by hand. If difficult or impossible to move, it may be due to a damaged keyway on the wheel shaft. Contact Technical Service Department.
- Lubricate washers and Castle Nut on pivot of lever. If necessary, remove roll pin and back nut off one flat (1/6-turn). Replace roll pin and test movement.

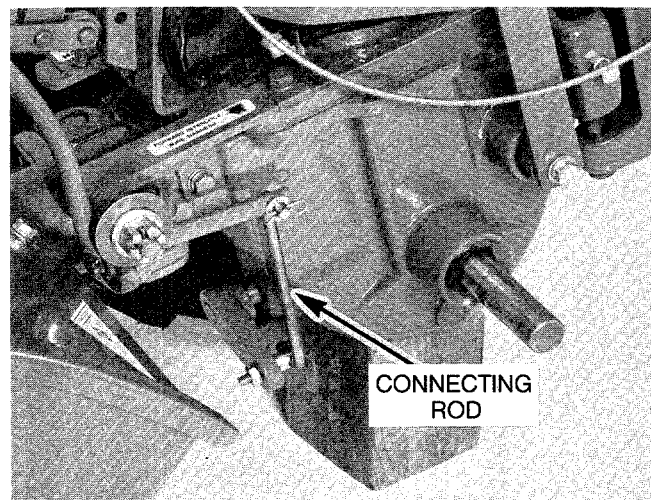

7-1: Check connecting rod, shifting linkage and eccentric lever.

PROBLEM**WHAT TO DO AND REFERENCE**

B. Lever shifts into “FAST” wheel gear, but not into “SLOW” wheel gear.

- Connecting rod at end of lever might be backwards, or bent in toward transmission housing and hitting it. Other shifting linkage might be bent. Straighten or replace linkage. See Photo 7-1.
- Clutch inside transmission may be binding. See Problem 2-A.

C. Lever moves freely, but won't shift in or out of gear.

- Eccentric shifting pin inside transmission may be broken (rare) or worn. Disconnect linkage from eccentric lever and try moving eccentric lever by hand. See Photo 7-1. If lever moves easily, contact Technical Service Department.

3. WHEELS AND TINES WON'T TURN

- Review operation of controls. See Sections 3 and 4.
- Check condition and adjustment of drive belt and reverse disc. See Section 6.
- Mounting bolt for transmission drive pulley may be loose. (See Photo 6-1 on page 37). If so, drive belt or reverse disc will turn pulley, but pulley won't turn main drive shaft.
- Worm gears that drive wheel and tiller shafts may be worn.

4. WHEELS TURN, BUT TINES WON'T

- Tines/PTO Clutch Lever must be in “ENGAGE” position. See Section 3.
- Tines/PTO Clutch Lever may need adjusting.
- Key for “dog” clutch on tine attachment main drive shaft may be missing or broken.
- Worm gears that drive tine shaft may be worn.
- Keys that hold tine holders to tine shaft may be missing or broken. To check, remove holders. See Section 6.
- Key for bronze worm gear on tine attachment main drive shaft may be missing or broken.

PROBLEM**WHAT TO DO AND REFERENCE**

5. TINES TURN, BUT WHEELS WON'T

- Check operation of Wheel Speed Lever. See Problem 2.
- Hi-Pro key inside wheel clutch may be missing or broken. If so, clutch will not turn wheel shaft.
- “FAST” and “SLOW” speed wheel gears may be worn. If only one gear is worn, there will only be one wheel speed.
- Worm gear that drives pinion shaft and pinion gears may be worn.
- “FAST” and “SLOW” speed pinion gears may be worn. If only one gear is worn, there will only be one wheel speed.
- Drive “dogs” on sides of wheel clutch may be worn or broken. If only one side of clutch is affected, there will only be one wheel speed.

6. WHEELS AND TINES TURN ON TOP OF GROUND, BUT STOP OR HESITATE IN SOIL

- Drive belt may be loose. See Section 6.
- Mounting bolt for transmission drive pulley may be loose. See Photo 6-1 on page 37.

7. TILLER JUMPS WHILE TILLING

- Depth Regulator Lever set too deep for soil conditions. Lower lever for shallower setting.
- Engine throttle speed too fast.
- Tiller wheel speed too fast for soil conditions. Change to “LOW” belt range or “SLOW” wheel speed.

8. DEPTH REGULATOR LEVER DIFFICULT TO MOVE

- Lubricate spring assembly and depth adjustment bar. See Section 6.
- Check for bent depth adjustment bar.

9. WHEEL AND SHAFT MOVE OUT TO ONE SIDE

- Snap ring on wheel shaft may be dislodged from its groove. Raise wheels off ground and check for back and forth play in shaft. If there is play, one or both snap rings are loose.

PROBLEM	WHAT TO DO AND REFERENCE
----------------	---------------------------------

10. TINE HOLDER BOLT BREAKS OR LOOSENS

- Check that tine holder keys are in keyways of tine shaft. Without key in holder, left side tine bolt will tighten and break; right side bolt will loosen. See Section 6.

11. TILLER PULLS TO ONE SIDE

- Check air pressure in tires. See Section 6.

12. POOR TRACTION

- Bar tread tires, tire chains, or wheel weights may be needed. See Section 9.

13. GEAR OIL LEAK FROM POWER UNIT OR TINE ATTACHMENT TRANSMISSIONS

- See Section 6.

14. ENGINE LACKS POWER

- Air cleaner restricted with dirt and/or oil. See Section 6.
- Spark plug wire loose or damaged. Spark plug worn or fouled. See Section 6.
- Engine under excessive work load. Use "SLOW" wheel speed and "LOW" belt range.
- Throttle cable could be loose or misadjusted. See Section 6.
- Make sure engine isn't running with choke partially engaged. See Section 3.
- Carburetor might need adjustment. See Section 6.
- Engine overheating. Check oil level, clean cooling fins. Oil may be dirty. Allow hot engine to cool before restarting.
- Dirt or water in fuel or fuel system.
- Engine crankcase low in oil, or over-full. Check oil level.
- Low engine compression. See Problem 25.

PROBLEM	WHAT TO DO AND REFERENCE
----------------	---------------------------------

15. ENGINE HARD STARTING

- Wheels/Tines/PTO Drive Lever not in "NEUTRAL".
- Fuel tank low or empty.
- Dirt or water in fuel or fuel system.
- Fuel line restricted.
- Choke not set properly. See Section 3.
- Spark plug worn or fouled (weak spark). See Section 6.
- Air cleaner restricted with dirt and/or oil. See Section 6.
- Throttle cable not properly adjusted. See Section 6.
- Engine throttle lever not free to move full distance.
- Throttle wire and linkage binding, or bent and not free to move.
- Low engine compression. See Problem 25.

16. ENGINE WON'T START

- See "Troubleshooting the Forward Interlock Safety System" in Section 6.
- Wheels/Tines/PTO Drive Lever not in "NEUTRAL"
- Fuel tank low or empty.
- Fuel line restricted or clogged.
- Choke not set properly. See Section 3.
- Water or dirt in fuel, and/or fuel system.
- Spark plug fouled or worn. Spark plug wire loose or damaged. See Section 6.
- Carburetor might need adjustment. See Section 6.
- Air filter clogged with oil or dirt. See Section 6.
- Carburetor float faulty (or float valve leaking)—if so, tap side of bowl lightly with handle of screwdriver.
- Stale fuel—won't vaporize properly, gums up carburetor float, channels and valves. Drain and add new fuel.
- Fuel tank shut-off valve not in "Open" position. See Section 2.

Electric Start Engines Only:

- Electrical connections loose or shorted against metal frames, brackets or covers. See Section 6.
- Battery discharged. See Section 6.
- Electric starter motor faulty. See Problem 30.

PROBLEM**WHAT TO DO AND REFERENCE**

17. ENGINE SHUTS OFF WHEN WHEELS/TINES/PTO DRIVE LEVER IS IN "FORWARD"

- See "Troubleshooting the Forward Interlock Safety System" in Section 6.

18. ENGINE DOES NOT SHUT OFF WHEN FORWARD INTERLOCK LEVERS ARE RELEASED WHILE WHEELS/TINES/PTO DRIVE LEVER IS IN "FORWARD"

- See "Troubleshooting the Forward Interlock Safety System" in Section 6.

19. ENGINE IDLES TOO FAST

- Carburetor may need adjustment. See Section 6.
- Check throttle cable adjustment. See Section 6.
- Check throttle linkage for freedom of motion.

20. ENGINE WON'T IDLE AT ALL

- Carburetor may need adjustment. See Section 6.

21. ENGINE HAS SLOW RECOVERY AFTER ABRUPTLY MOVING THROTTLE FROM IDLE TO HIGH SPEED

- Carburetor may need adjustment. See Section 6.

PROBLEM**WHAT TO DO AND REFERENCE**

22. ENGINE STALLS (WITHOUT LOAD)

- Cold engine, allow few minutes warm-up time before moving tiller.
- Fuel line restricted or blocked.
- Carburetor may need adjustment. See Section 6.
- Loose ignition system connections. *1.

23. ENGINE OVERHEATS

- Clean engine cooling fins, shroud and covers. See Section 6.
- Check for broken flywheel fins (under engine shroud). *1.
- Check oil level for too much or too little oil.

24. ENGINE BLOWS BLACK SMOKE

- Carburetor set for too rich a mixture. Lean out. See Section 6.
- Air filter may be clogged.
- Choke may be in "FULL CHOKE" setting. Return to "CHOKE OFF".

25. LOW COMPRESSION

- Pull recoil starter rope a few inches until you feel resistance. Judge if amount of resistance you feel is normal. *1.
- Blown head gasket, or loose head bolts—check two bolts nearest muffler first. *1.
- Valve stuck open, no real compression. *1.
- Excessive piston ring wear. *1.

26. ENGINE BACKFIRES

- Check spark plug gap. See Section 6.
- Mixture too lean, adjust carburetor. See Section 6.
- Loose cylinder head, or head gasket leak. *1.
- Loose carburetor or intake adaptor plate.

*1 See authorized engine service dealer.

PROBLEM**WHAT TO DO AND REFERENCE****27. ENGINE RUNS ERRATICALLY**

- Water or dirt in gasoline or carburetor.
- Carburetor may need adjustment. See Section 6.
- Spark plug fouled or dirty. Spark plug wire loose or damaged. See Section 6.
- Loose or cracked carburetor.
- Governor linkage not adjusted properly, or binding. *1 Do not attempt to service by yourself.
- Governor not functioning properly. *1 Do not attempt to service by yourself.

28. ENGINE CONSUMES EXCESSIVE AMOUNTS OF OIL

- Piston rings worn, broken or not installed properly. Dirt might be getting through carburetor to engine. *1.
- Check pan gasket, engine seals and drain plugs for leaks. *1.

29. ENGINE RUNS WELL, BUT LABORS UNDER TILLER LOAD

- Check governor linkage for freedom of movement.
- Check throttle setting and carburetor adjustment.
- Tilling depth possibly too deep, lower adjustment bar.
- Possible worn bronze tiller worm gear or loose drive shaft (on well-used tiller).

30. KEY SWITCH WILL NOT START ENGINE

- Check battery terminals for corrosion. See Section 6.
- Discharged battery. See Section 6.
- Defective solenoid. See Section 6.
- Short in key switch or key switch wire harness. See Section 6.
- Check starter motor mounting bolts for looseness.
- Have engine service dealer inspect starter motor.

PROBLEM**WHAT TO DO AND REFERENCE****31. ENGINE WON'T RECHARGE BATTERY**

- Battery won't take or hold a charge. Have it tested by a qualified battery technician.
- Recharging line diode or engine stator might be defective. *1.
- Battery recharging wire may be loose or broken.

32. BATTERY GETS HOT AND/OR FOAMS

- Battery acid level low. See Section 6.
- Battery acid level too high (foams). See Section 6.

We're here to serve you!

We want to hear from you if you have any questions or problems concerning your tiller.

Simply call our Technical Service Department for prompt, efficient service.

*1 See authorized engine service dealer.

SECTION 8: Specifications

TILLER SPECIFICATIONS

HEIGHT

(Approximate minimum heights)
 With handlebars in lowest setting:
 37 $\frac{1}{4}$ "**
 With handlebars in highest setting:
 49 $\frac{1}{2}$ "**
 Without handlebars: 33 $\frac{3}{4}$ "**
 * Tines resting on ground.
 ** Measured from knob on Wheels/
 Tines/PTO Drive Lever to ground.

LENGTH

(Approximate minimum lengths)
 With handlebars: 60"
 Without handlebars: 56 $\frac{1}{2}$ "

WIDTH

Hood width: 22 $\frac{1}{2}$ "
 Tilling width: 20"

WEIGHT

(Approximate weights of assembled and oiled tillers, less gasoline and shipping containers)
 7 HP Recoil Start Model: 284 lbs.*
 7 HP Electric Start Model: 310 lbs.*
 8 HP Recoil Start Model: 296 lbs.
 8 HP Electric Start Model: 324 lbs.
 * Add 2-3 lbs. if equipped with bar tread tires.

TRANSMISSION

Consists of two separate transmissions, the Power Unit transmission and the Tine Attachment transmission. Both transmissions

are encased in cast iron housings and operate in separate baths of gear oil. The housings are securely connected by a locking collar, a dowel pin, and two large swing-bolts. By loosening the swing-bolts, the Power Unit can be disconnected from the Tine Attachment and used as a separate power source for optional powered and non-powered PTO attachments.

TRANSMISSION GEAR OIL

Small Top-Offs: SAE 140, SAE 85W-140, or SAE 80W-90 with API rating of GL-3 or GL-5.

Full Replacement: SAE 140 or SAE 85W-140 with API rating of GL-3 only.

Power Unit Gear Oil Capacity; Approximately 60 oz., but use oil level check hole as final guide.

Tine Attachment Gear Oil Capacity: Approximately 16 oz., but use transmission dipstick as final guide.

WHEELS

Single piece steel; 8" diameter.

TIRES

7 HP Model comes equipped with 4:80 x 8" diamond tread tires (bar tread tires are optional).

8 HP Model comes equipped with 4:80 x 8" bar tread tires.

Air pressure: 10 to 20 psi.

7 HP BRIGGS & STRATTON ENGINE SPECIFICATIONS

GENERAL DESCRIPTION

Four-cycle, single cylinder, L-head, air cooled, horizontal crankshaft engine. Industrial/Commercial (I/C) rated, with cast iron bore. Recoil start with compression release is standard. Key electric start, with 12-volt battery and automatic recharging during engine operation, is optional. Transistorized electronic ignition system eliminates the need for points and condenser.

HORSEPOWER

7 HP (16.8 Cubic Inch Displacement).

MODELS

Recoil Start: 171432—Type 0529
 Electric Start: 171437—Type 0530

ENGINE WEIGHTS

(Approximate)
 Recoil Start: 47 lbs.
 Electric Start: 51 lbs.

FUEL SYSTEM

Side-mounted fuel tank with 1 gallon capacity. Equipped with fuel tank shut-off valve located below fuel tank.

FUEL

Clean, fresh, lead-free automotive gasoline is recommended. Leaded gasoline may be used if unleaded is unavailable. Use gasoline that has a minimum octane rating of 77. Do not use gasoline containing Methanol. The use of gasoline which contains alcohol (such as gasohol) is not recommended. If using gasohol, refer to the Briggs & Stratton Operating and Maintenance Instructions booklet for specific cautions and recommendations for this type of fuel.

WHEEL AND TINE SPEEDS

At 3000 RPM (Revolutions Per Minute) engine speed, the wheel and tine speeds are:

BELT POSITION	WHEEL SPEED		TINE SPEED
	LEVER POSITION	WHEEL SPEED	
Low Range	Slow	.5 MPH	146 RPM
Low Range	Fast	1.2 MPH	146 RPM
High Range	Slow	.7 MPH	200 RPM
High Range	Fast	1.72 MPH	200 RPM

8 HP KOHLER MAGNUM ENGINE SPECIFICATIONS

MOTOR OIL

See Section 6 for recommended service classifications and viscosities. Oil sump capacity is approximately 2¾ pints, however always be sure to add enough oil so that it is to the point of overflow in the oil fill tube. Dual oil fill tubes and dual oil drain plugs.

SPARK PLUG

Spark plug gap: .030".

Type:

Champion CJ8 or Autolite 235. In some areas, local law requires the use of a resistor spark plug. If your engine was originally equipped with this type of plug, use one of the following plugs for replacement: Resistor Short Plug: Champion RCJ8 or Autolite 245; Resistor Long Plug: Champion RJ8 or Autolite 306.

BEARINGS

Ball bearings are used at both ends of crankshaft.

AIR CLEANER

Advanced two-stage air cleaner with automotive type paper fiber element covered by oil-soaked foam precleaner. Cover is chrome plated.

GOVERNOR

Mechanical type.

BREATHER

Installed through air cleaner.

CHOKE

Manually operated at engine.

GENERAL DESCRIPTION

Four-cycle, single cylinder, air cooled, horizontal crankshaft engine. Advanced design features low profile, modular configuration. Cast iron engine block, flywheel and camshaft. Cylinder can be re-bored several times to extend engine life, if ever necessary. Recoil start with Automatic Compression Release is standard. Key electric start, with 12-volt battery and automatic recharging during engine operation, is optional. Solid state inductive electronic ignition system eliminates the need for ignition tune-ups.

HORSEPOWER

8 HP (18.6 Cubic Inch Displacement). Bore: 2.94 inches. Stroke: 2.75 inches.

MODELS

Recoil Start: M8T-PS301512
Electric Start: M8ST-PS301513

ENGINE WEIGHTS

(Approximate)
Recoil Start: 69 lbs.
Electric Start: 71 lbs.

FUEL SYSTEM

Side-mounted fuel tank with 1¼ gallon capacity. Cam-driven fuel pump for positive fuel delivery. Plastic tank prevents rust and corrosion.

FUEL

Fresh, clean, unleaded regular automotive gasoline with a pump sticker octane rating of 87 or higher. (Leaded "regular" grade gasoline is an acceptable substitute.)

MOTOR OIL

See Section 6 for recommended service classifications and viscosities. Oil sump capacity is approximately 32 oz., but always use the dipstick as a final guide.

SPARK PLUG

Spark plug gap: .025".
Type: Champion RCJ-8 or equivalent. If engine is equipped with a Champion RJ-17LM resistor spark plug, it should be replaced with an RJ-17LM plug only.

CRANKSHAFT

Heat-treated ductile iron with integral counterweights. Rotation is counterclockwise when viewed from PTO (Power Take Off) end.

BEARINGS

Ball bearings are used at both ends of crankshaft.

VALVE TRAIN COMPONENTS

High carbon steel intake valve. Stellite® faced exhaust valve and exhaust valve seat insert, with valve rotator.

AIR CLEANER

Two-stage air cleaner with dry type paper element covered by oil-soaked foam precleaner.

GOVERNOR

Precision mechanical flyweight type.

BREATHER

Closed crankcase ventilation breather system keeps dirt and dust from entering crankcase.

CHOKE

Manually operated at engine.

SECTION 9: Attachments and Accessories

The following pages show the optional attachments and accessories that are available for use with your tiller or power unit as of the

date this Manual was printed. Please take a few minutes to read these pages. You may find just the item you need to save you hours

of work . . . or to accomplish specific tasks in your garden or around your home.

TROY-BILT® Hiller/Furrower Attachment

The Hiller/Furrower is our most popular attachment because it has so many uses both in and out of the garden. Featuring “instant on-off” versatility, the attachment can be switched from a furrower to a hiller, and back again, in just seconds—and without tools. It mounts to the rear of the depth regulator mounting bracket, as shown in Photo 9-1.

The furrower blade can easily be adjusted with the depth regulator to only scratch the surface for making rows to plant peas, beans, and other seeds set close to the surface. Lower the furrower (as

deep as 8 inches) and quickly dig trenches for transplants like tomatoes, celery, peppers, cabbages, asparagus, melons and strawberries. You can also use the furrower to dig ditches for drainage or irrigation projects, for laying underground pipes, and for trench composting.

With the hiller wings attached, it can be used to cover and kill weeds, side-dress plants, cover potatoes or seeds planted in a furrow, and make raised bed gardens. The hiller wings handle rows from 30 to 40 inches apart.

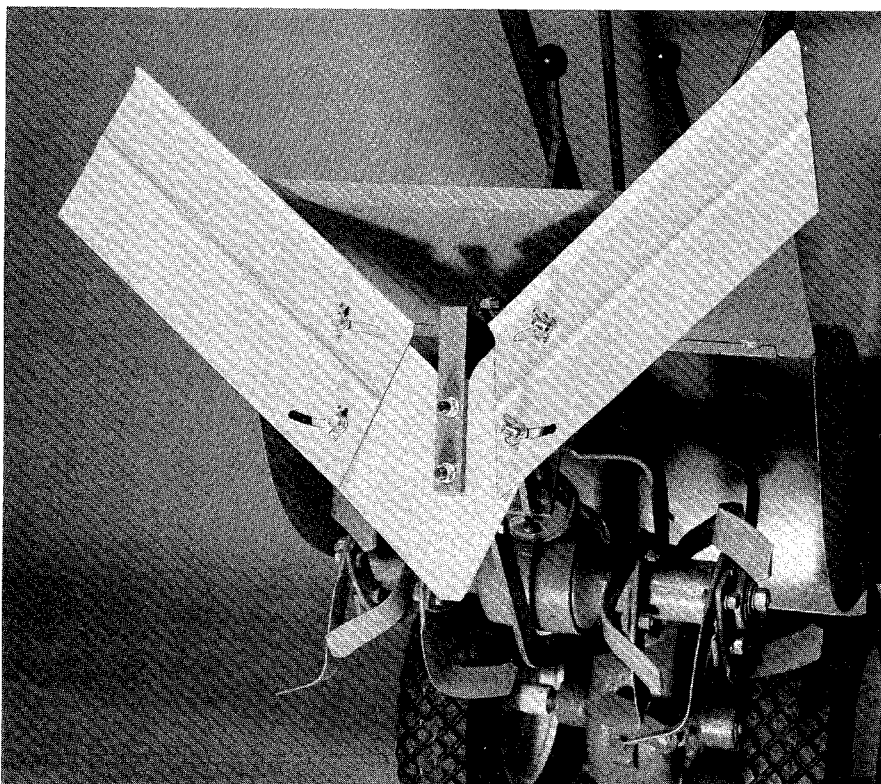

9-1: Hiller/Furrower attachment.

Custom Tilling Tines

Our standard Bolo Tines do a great job and are more than adequate for most TROY-BILT® Tiller owners. But if you do custom tilling for long hours—or if your soil is extra rocky, gritty, or sandy—you’ll find the ¼-inch thick, hard-faced Custom Tilling Tines will be well worth the extra dollars they cost. See Photo 9-2.

Made from a special cast, high chrome carbon alloy, these hard-faced tines better resist the severe abrasive action of rocky, gritty soil as compared to the standard Bolo Tines—and can last up to 2½ times longer.

The tines come with easy-to-follow assembly instructions and mount to the Bolo Tine holders that came factory installed on your tiller.

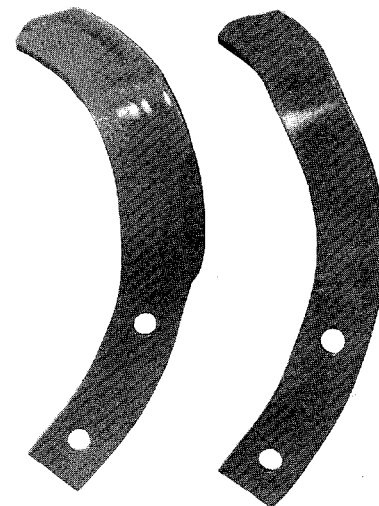

CUSTOM TINE STANDARD TINE

9-2: Use Custom Tilling Tines in tougher soils.

TROY-BILT® Row Marker Attachment

If you like straight, neat, picture-perfect rows in your garden, then you'll enjoy owning a Row Marker Attachment—see Photo 9-3. It hooks up quickly to the Hiller/Furrower Attachment and eliminates the need for string, stakes, and measuring tape.

Neat, even rows not only make weeding and harvesting easier, they also make your garden more attractive and allow you to make maximum use of your available space. And, you'll appreciate the straight rows even more if you lay out furrows, dig compost trenches, or make raised beds.

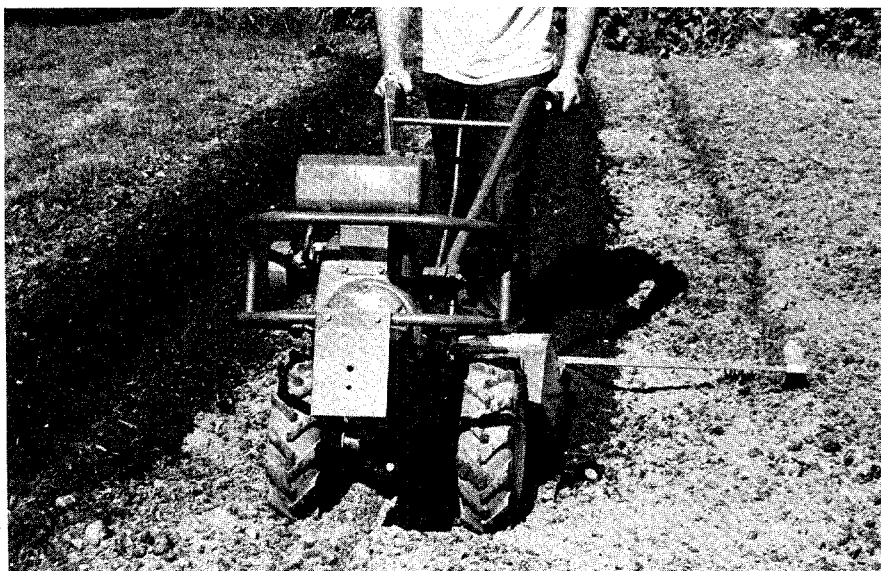

9-3: Use Row Marker Attachment for straight, neat rows.

The Row Marker arm extends from 28" to 49¾", allowing you to vary the width between rows ac-

ording to the crop you're planting. Width adjustment takes only a few seconds and requires no tools.

TROY-BILT® Wrap-Around Bumper/Guard

The heavy-duty Wrap-Around Bumper/Guard comes as an extra bonus when you buy the complete Dozer/Snow Blade Attachment, or it can be ordered separately. Either way, it's a solid investment in engine protection.

As shown in Photo 9-4, the bumper will protect the engine against damage from all sorts of blows (we've tested it under the worst conditions to make sure it protects the carburetor and the blower housing—and it does). The wrap-around design encloses and protects your carburetor against such mishaps as bumping into trees, fences, posts, garage and barn doorways, stone walls and parked vehicles. The cost of replacing a carburetor today can be well worth the protection provided by the bumper. In addition, the bumper also protects the engine's entire blower housing including the recoil starter assembly.

Besides protecting your tiller from bumps and scrapes, the bumper is also useful as a handy

tie-down in a trailer or pickup truck. And, it's a comfortable, secure handhold for pulling or lifting the tiller.

The bumper is made of one-inch, high-strength, steel tubing, welded for maximum strength. The width of the bumper is 22½".

Installing the bumper is easy with the simple step-by-step instructions provided—no special skills needed. And, if you decide to purchase a Dozer/Snow Blade later, we have a special kit which includes easy-to-follow instructions for attaching the blade.



9-4: The Bumper/Guard prevents engine damage from accidental mishaps.

TROY-BILT® Dozer/Snow Blade Attachment

The Dozer/Snow Blade is a versatile “homestead helper”. In the winter, the blade will move a foot or more of light snow, or 6 to 8 inches of heavy, wet snow. At other times of the year, it can be used for moving or spreading sand, gravel, loose dirt, grain, sawdust, fodder, mulches and manures. It’s also an ideal tool for medium-duty landscaping, and for backfilling trenches—especially in tight quarters where larger equipment won’t fit.

As shown in Photo 9-5, the blade attaches to the front of the Wrap-Around Bumper Guard. When the blade is removed, the bumper guard stays in place, offering protection to the engine from accidental bumps against doors, fences and trees.

Of course, the tiller and blade is not a bulldozer meant to cut into unbroken soil or push very heavy

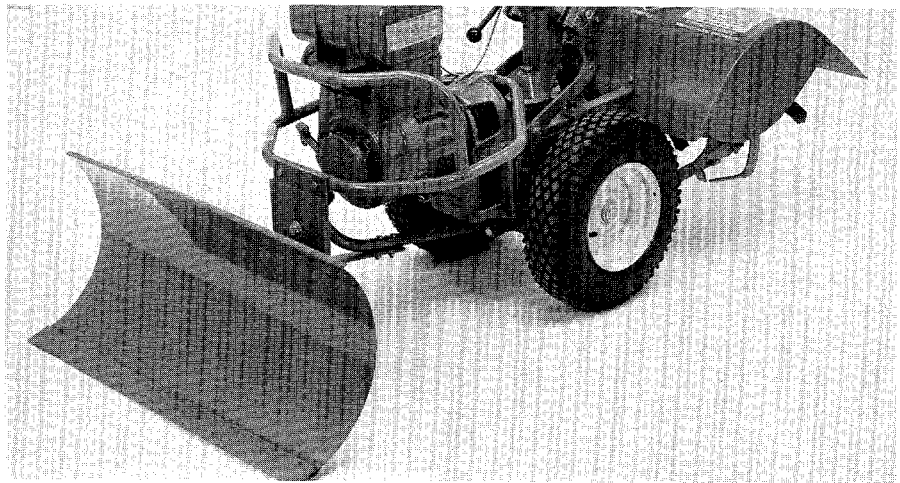

9-5: The Dozer/Snow Blade Attachment includes the Wrap-Around Bumper Guard.

loads . . . but it’s a great investment at a very reasonable price! You can set the blade at any one of five positions: straight ahead or at either of two angles on the right or left so you can do special jobs faster and better. With this flexibility,

you can move snow to either side of a walk, or backfill in one pass. Changing the blade angle in seconds is simply a matter of removing a pin and changing positions.

The blade weighs 41 lbs. and measures 15" x 32".

Wheel Weights

Wheel weights increase traction and reduce wheel slippage by concentrating extra weight directly on the wheels. See Photo 9-6. As an added benefit, they also help to stabilize the tiller in rough terrain or in hard tilling conditions.

The weights are shipped empty

and can be filled with a variety of materials including concrete, sand, gravel, scrap iron, etc.

To install the weights you will have to drill two holes in the wheels (using a common, $\frac{3}{8}$ " drill bit). Detailed instructions accompany each set of wheel weights.

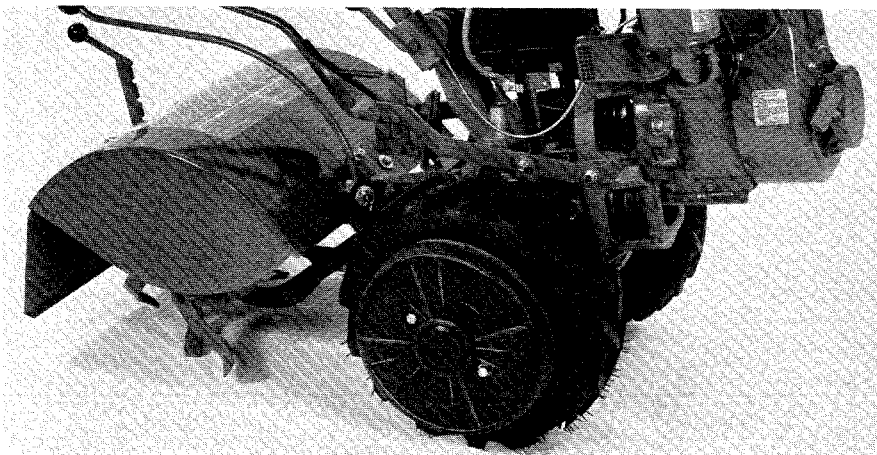

9-6. Wheel weights increase traction.

TROY-BILT® Tire Chains

When extra traction is needed because of certain soil conditions or when snowplowing, the use of tire chains can be very helpful (Photo 9-7). The chains fit either standard or bar tread tires and can be installed in minutes. They’re especially recommended for use when plowing snow, or if you do custom garden tilling, where you’ll likely meet a variety of soil conditions.

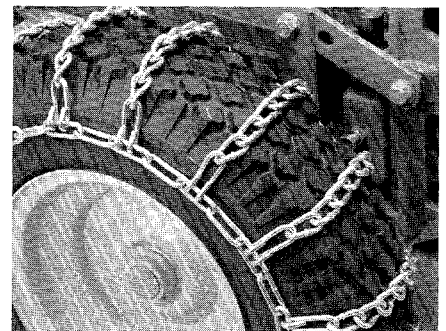

9-7: Standard tread tire with chains.

Bar Tread Tires

Bar tread tires have deep, agricultural style traction grips and are particularly helpful in soft, muddy or sandy soils. These tubeless, pneumatic tires come mounted on single piece steel wheels, ready for installation on your tiller. See Photo 9-8.

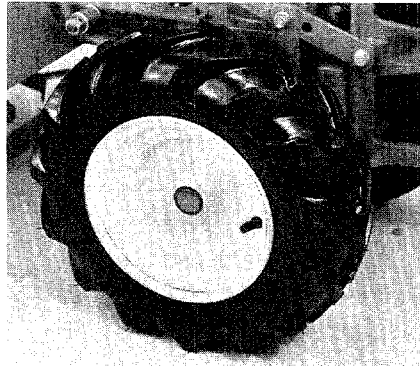

9-8: Bar Tread tire fits all HORSE Models.

TROY-BILT® Tow Hitch Attachment

You can convert your tiller into a tractor-type hauling unit in no time with the Tow Hitch Attachment. As shown in Photo 9-9, the Tow Hitch connects quickly to the rear of the Power Unit and comes with a heavy-duty pin and dust caps.

This is a standard-type Tow Hitch which can be used for pulling attachments such as the Sweep Cultivator. You may also wish to use it to attach other equipment you may have, such as a lawn roller, a four-

wheel shredder, a drag mat harrow, or other implements that handle well and safely behind the Power Unit. The maximum load capacity of the Tow Hitch is 400 lbs.

The Tow Hitch should be used only with attachments that have a double-tongue connection. Attachments with only a single-tongue connection should not be used because they allow the Power Unit to tip excessively forward or backward, and make it hard to control. All TROY-BILT non-powered attachments have double-tongue connections.

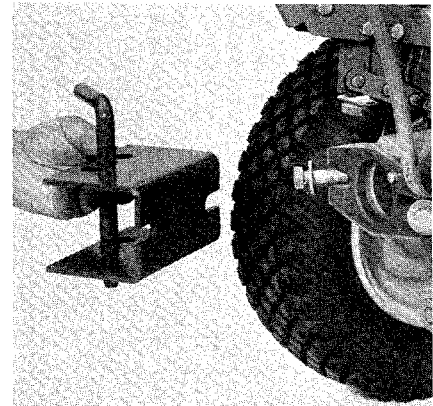

9-9: The Tow Hitch attaches to back of Power Unit.

TROY-BILT® PTO Chipper/Shredder

The TROY-BILT® PTO Chipper/Shredder provides a convenient, easy means of cleaning up unsightly brush piles and other organic matter on your property, with the added bonus of providing an unending supply of useful wood chips, mulch and compost for your landscaping and gardening needs. See Photo 9-10.

The unit hooks up quickly to your tiller and goes easily wherever your tiller can go. The swivel wheel on the back of the unit rotates for extra maneuverability, and when you've finished your chores, the unit stands by itself on its own built-in stand.

The unit will handle limbs up to 3" in diameter and tough stalks and vines that are thicker than 1" in diameter, in addition to all man-

ner of organic material including leaves, grass, weeds, brush, paper and sod.

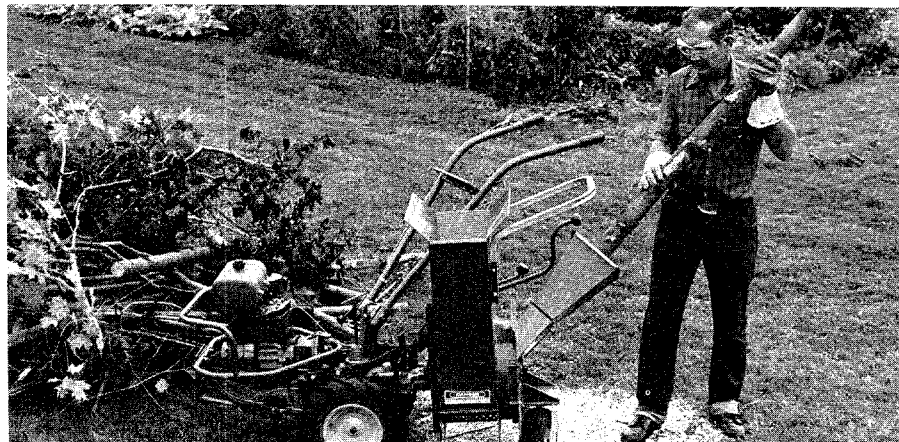

9-10: The PTO Chipper/Shredder.

TROY-BILT® Log Splitter

The TROY-BILT® Log Splitter provides you with a convenient and easy means of splitting large quantities of wood. When hooked-up to the Power Unit's PTO clutch, the tiller's engine runs the splitter's hydraulic pump, providing you with 13 tons of steady, unhurried and predictable splitting force (see Photo 9-11). As an added benefit, the power-driven mobility provided by the Power Unit allows you to move the splitter to and from your woodpile, over to a neighbor's place, or along the woodpile to a fresh supply of logs.

The Log Splitter has many top-of-the-line features including: 15-second splitting cycle, all the way forward and back; two-stage hydraulic pump that automatically shifts into "low gear" to provide

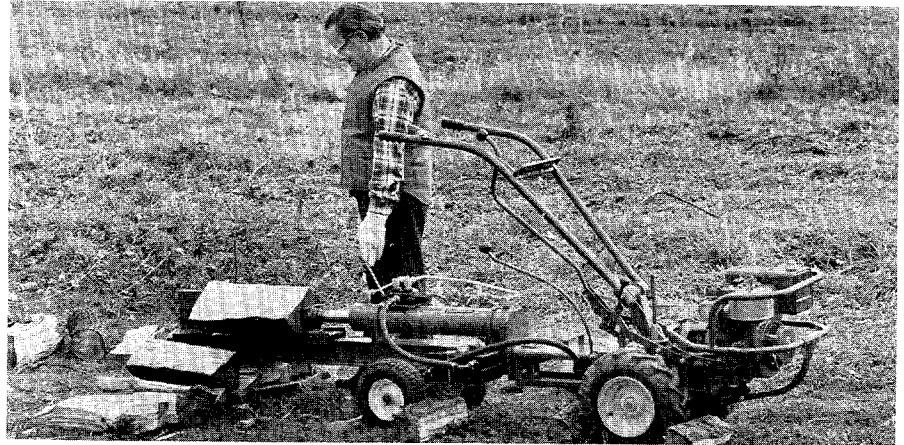

9-11: The Log Splitter produces 13 tons of hydraulic pressure.

four times as much pressure on tough-to-split pieces; slim-cut wedge design that will split even the greenest, stringiest elm; and an auto-control valve that allows the ram to make the return stroke

by itself. It will handle log sizes up to 26" long.

You can expect to split about half a cord per hour working alone, and up to a full cord if you have a helper and don't stop to stack.

TROY-BILT® Generator

The TROY-BILT® Generator can be attached to your Power Unit to provide remote electrical power for many portable tools around your home and property. The Generator delivers 2600 watts at 60 hz with the 7 and 8 HP engines. See Photo 9-12.

The ability to move your Power Unit and Generator from one location to another is a unique and particularly handy feature. Here are just a few of its possible uses: operate power tools for repair jobs; bring power to a building site for saws, drills, etc.; run a pump to drain a pond or tank; light an outdoor area for night work; use hedge trimmers, weed trimmers, sprayers, etc. around your grounds and orchard.

It can also be used as an emergency standby generator to provide 120 and 240 volt power for a limited number of household appliances, provided proper electrical connections have been installed by a competent electrical contractor. NOTE: The unit must not be left

unattended unless protected from access by a padlocked fence.

Specifications include: 120/240-volt capacity; built-in voltage regu-

lator (to protect sensitive appliances); built-in frequency meter; three receptacles (one 240 V, 10.8 amps., and two 120 V, 21.7 amps.).

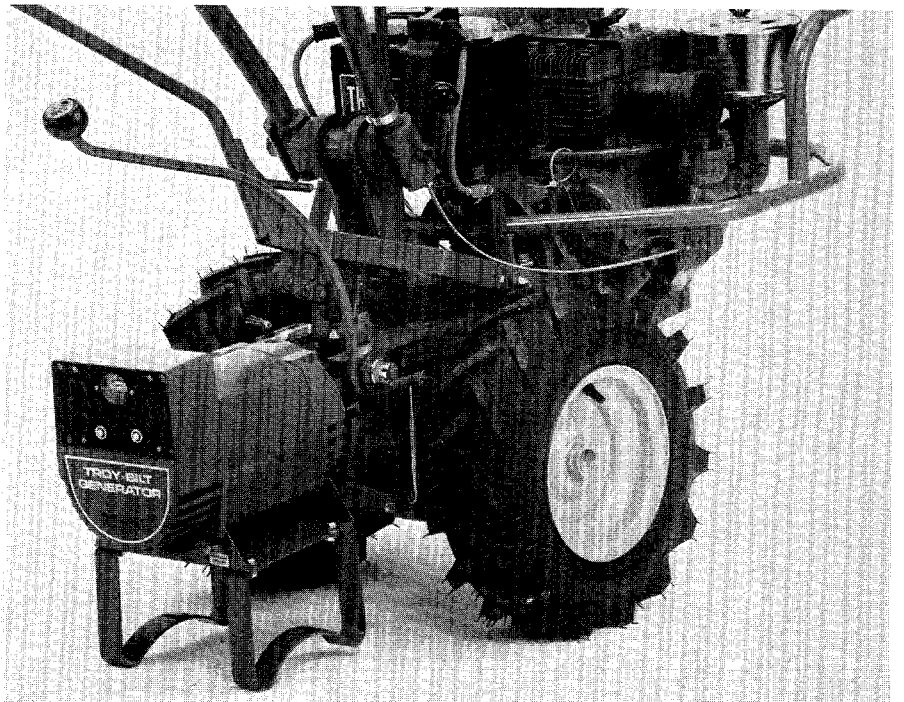

9-12: Take portable electric power where you need it with the TROY-BILT® Generator.

Sweep Cultivator Attachment

The Sweep Cultivator is a specialized tool designed for between-row cultivation of crops. Instead of stirring the soil, it slices through just below the surface to eliminate practically any weeds in its path.

As shown in Photo 9-13, the Sweep mounts easily to the Tow Hitch Attachment at the rear of the Power Unit. The blade is made of high carbon, heat treated steel and measures 2" wide (overall wing-span is 20").

The unique way the Sweep works, skimming along just underneath the soil's surface without turning the soil over, makes this the ideal tool for use in dry, dusty conditions where it is important to

keep soil disturbance to a minimum. And, because of its 20" wide cutting path, it does an effective cultivating job at a fast speed.

The Sweep naturally cultivates shallow, which helps to prevent weed seeds from being brought to the soil's surface. This shallow cultivation feature also means there's less chance of damaging the roots of your vegetables. For deeper or more shallow cultivating, the depth of the blade can be changed with just a simple adjustment.

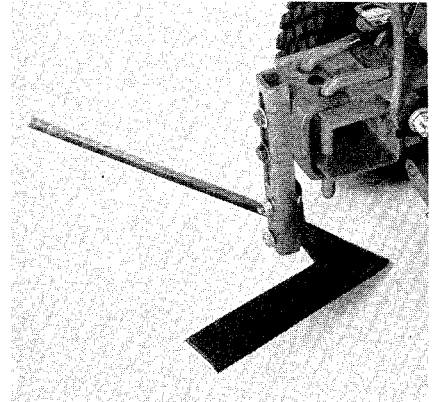

9-13: The Sweep Cultivator mounts to the Tow Hitch Attachment.

TROY-BILT Kickstand

The Kickstand provides a sturdy front support for the Power Unit, preventing the engine from tipping forward when you are connecting or disconnecting attachments. It also keeps the Power Unit in a level position when there is no attachment, or when there is an attachment which isn't heavy enough to weigh the tiller down in the back.

As shown in Photo 9-14, the Kickstand attaches to the Wrap-Around Bumper/Guard which has two mounting holes provided in its bottom brace.

The Kickstand is spring-loaded so that it easily swings up out of the way when its use is not required (if you forget to raise the Kickstand, it will automatically disengage itself as you move the Power Unit forward).

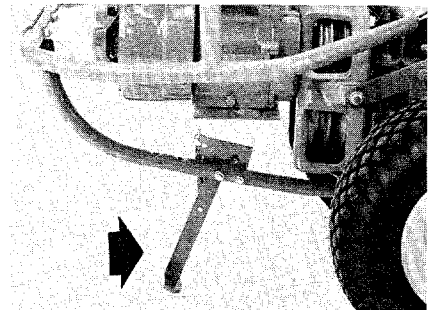

9-14: Kickstand prevents engine from tipping forward when attachments are removed from Power Unit.

Tine Attachment Cradle

The Tine Attachment Cradle is a convenient accessory for safely removing the tine attachment from the Power Unit. It positions the tine attachment at just the right height for sliding the Power Unit connection in and out, eliminating the need for lifting and pulling on the tine attachment. See Photo 9-15.

The cradle also provides a secure stand for storing your tine attachment while using the Power Unit with other attachments. It supports the tine attachment in a level position which prevents leakage of transmission gear oil from the dipstick/oil fill hole.

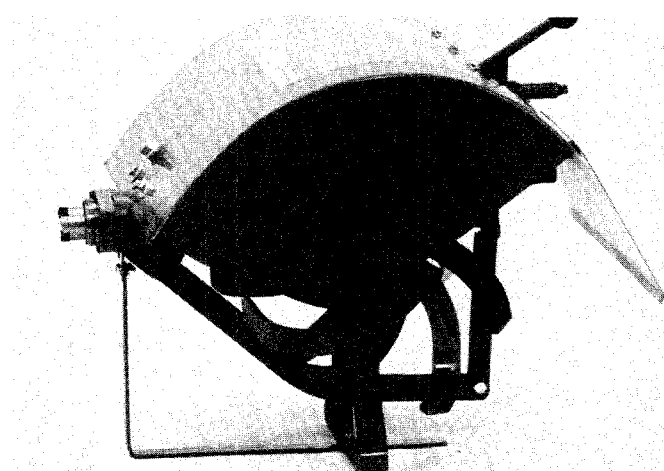

9-15: Cradle provides safe, secure support for the tine attachment.

INDEX

Air Cleaner,

- Cleaning Foam Precleaner, 52
- Replacing Paper Element, 52
- Service Schedule, 52

Air Cooling System, Engine, 54

Air Pressure, Tires, 50, 70

Attachments and Accessories,

- Bar Tread Tires, 75
- Custom Tilling Tines, 72
- Dozer/Snow Blade, 74
- Generator, 76
- Hiller/Furrower, 30, 72
- Kickstand, 32, 77
- Log Splitter, 76
- PTO Chipper/Shredder, 75
- Row Marker, 73
- Sweep Cultivator, 77
- Tine Cradle, 32, 77
- Tire Chains, 74
- Tow Hitch, 75
- Wheel Weights, 74
- Wrap-Around Bumper/Guard, 73

Authorized Engine Service, 4

Bar Tread Tires, 75

Battery,

- Care in Service, 56
- Care in Storage, 56
- Removal/Replacement, 57
- Service Schedule, 56
- Troubleshooting, 58, 69

Beds, Raised, 30

Belt,

- Adjusting Tension, 41-42
- Changing Speed Ranges, 22-24
- Inspection, 41
- Replacement, 43-44

Bolo Tines (see "Tines")

Bolts and Nuts, 37

Break-in Operation, 16

Bumper/Guard, 73

Cable, Throttle (see "Throttle Lever")

Carburetor, 55

Chains, Tire, 74

Chart, Maintenance, 36

Choke Control,

- Function, 14
- Operation, 14, 19

Chipper/Shredder, 75

Clutch Roller, 9-10

Cold Weather Operation, 18

Composting, 26, 30

Controls,

- Engine, 13-15
- Tiller/Power Unit, 9-13

Cornstalks, 27

Cover Crops, 26

Cradle, Tine, 32, 77

Crop Residues, 26

Cultivating, 26

Custom Tilling Tines, 72

Decals, 8

Depth Regulator Lever,

- Function, 12
- Operation, 12
- Tiller Depths, 12, 25-28
- Troubleshooting, 66

Disc Reverse,

- Inspection, 44
- Replacement, 44

Dozer/Snow Blade, 74

Drive Belt (see "Belt")

Eccentric Lever, 37, 65

Electric Start System,

- Maintenance, 56-57
- Operation, 15
- Starting With Recoil Rope, 19
- Troubleshooting, 58-60
- (Also see "Battery")

Engine,

- Air Cleaner, 52
- Air Cooling System, 54
- Authorized Service, 4
- Carburetor, 55
- Choke Control, 14, 19
- Cold Weather Operation, 18
- Controls, 13-15
- Fuel, 16, 70-71
- Fuel Valve, 15
- Ignition System, 54
- Key Switch Starter, 15, 19, 60
- Model Code Number, 5
- Off-Season Storage, 8, 60
- Oil, 50-51
- Operation, 18-19
- Recoil Starter, 14, 19
- Spark Plug, 54, 71
- Specifications, 70
- Starting/Stopping, 18-21
- Throttle Cable, 13, 53
- Throttle Lever, 13
- Troubleshooting, 67-69

Factory Service, 4

Footprints, 26

Forward Interlock Levers,

- Function, 10
- Inspection, 61
- Operation, 10
- Test Procedure, 17

Troubleshooting, 61

Forward Operation, 9-13, 20-22

Free Wheel, 11

Fuel, 16, 70-71

Fuel Valve, 15

Furrower, 30, 72

Gardening,

- Cornstalks, 27
- Cover Crops, 26
- Crop Residues, 26
- Cultivating, 26
- Green Manures, 26
- Leaves, 30
- Mulch, 26
- Power Composting, 26
- Raised Beds, 30
- Seedbeds, 25
- Sheet Composting, 30
- Slopes/Terraces, 28-29
- Trench Composting, 29
- Wide Rows, 31

Gasoline, 16, 70-71

Gear Oil,

- Adding, 40
- Changing, 40
- Checking for Leaks, 38
- Checking Level, 39
- Type and Capacity, 40, 70

Generator, 76

Grease, 38

Green Manures, 26

Handlebar Height Adjustment, 13

Height, Tiller, 70

Hiller/Furrower, 30, 72

Hitch, Tow, 75

Housing Cover, Tiller, 37

Identification Numbers, Engine, 5

Idle Speed, Carburetor, 55

Ignition System, 54

Introduction, 2

J

Key Switch Starter,

- Function, 15
- Operation, 15, 19
- Troubleshooting, 59-60

Kickstand, 32, 77

Kohler (see "Engine")

Leaks, Oil, 38

Leaves, 30

Length, Tiller, 70

Levers,

- Choke Control, 14, 19
- Depth Regulator, 12, 25-28, 66
- Engine Throttle, 13, 53
- Forward Interlock, 10, 17, 61
- Handlebar Height, 13
- Tines/PTO Clutch, 12, 38
- Wheels/Tines/PTO Drive, 9-10, 65

Loading/Unloading, 22

Log Splitter, 76

Lubrication Points, 38

Maintenance,

- Air Cleaner, 52
- Air Cooling System, 54
- Battery, 56-57
- Bolts and Nuts, 37
- Carburetor, 55
- Chart, 36, 78
- Drive Belt, 41-44
- Engine Oil, 50-51
- Ignition System, 54
- Lubrication Points, 38
- Reverse Drive, 44-47
- Spark Plug, 54, 71
- Storage, 8, 56, 60
- Throttle Cable, 53
- Tine Shaft, 49
- Tines, 28, 48
- Transmission Gear Oil, 38-40

Manures, Green, 26

Motor Oil (see "Oil, Engine")

Mulch, 26

Neutral (see "Wheels/Tines/PTO Drive Lever")

Non-Powered Attachments, 34-35

Nuts and Bolts, 37

Off-Season Storage, 8, 56, 60

Oil, Engine,

- Adding, 51
- Changing, 51
- Checking Level, 51
- Service Schedule, 50
- Type and Capacity, 51

Oil, Transmission Gear,

- Adding, 40
- Changing, 40
- Checking for Leaks, 38
- Checking Level, 39
- Type and Capacity, 40, 70

Operating Instructions,

- Power Unit, 32-35
- Tiller, 16-24

Options/Attachments (see

"Attachments and Accessories)

Parts, Ordering, 4

Power Composting, 26

PTO Power Unit,

- Description, 3
- Operation, 32-35

Pulley, Transmission, 37

Q

Raised Beds, 30

Recoil Starter, 15, 19

Reverse Drive Maintenance,

- Adjustments, 45-47
- Reverse Disc, 44

Reverse Operation (see "Wheels/Tines/PTO Drive Lever")

Row Marker, 73

Safety Instructions, 6-8

Seedbeds, 25

Serial Number, Tiller, 5

Service,

- Engine, 4
- Factory, 4

Sheet Composting, 30

Shredder/Chipper, 75

Slope Gardening, 28-29

Solenoid, 58-60

Spark Plug, 54, 71

Specifications, 70

Speeds, 22-24, 70

Stationary Attachments, 34-35

Starting/Stopping,

- Engine, 18-19
- PTO Power Unit, 34-35
- Tiller, 18-21

Storage, 8, 56, 60

Sweep Cultivator, 77

Swing-Bolts, 33, 37

Terraces, 29

Throttle Cable, 13, 53

Throttle Lever, 13

Tiller,

- Controls, 9-15
- Maintenance, 36-64
- Operation, 16-24
- Safety, 6-8
- Specifications, 70
- Troubleshooting, 65-69

Tilling Depths, 25

Tine Attachment, 32-33, 39

Tine Cradle, 32, 77

Tine Holders, 48

Tine Shaft, 49

Tine Speeds, 22, 24, 70

Tines,

- Cleaning, 28
- Custom Tilling, 72
- Inspection, 48
- Single Tine Replacement, 48

Tines/PTO Clutch Lever, 12

- Function, 12
- Operation, 12
- Maintenance, 38

Tires,

- Air Pressure, 50, 70
- Bar Tread, 75
- Chains, 74
- Removing Wheels, 50

Tow Hitch, 75

Transmission Gear Oil (see "Oil, Transmission Gear")

Transporting Tiller, 22

Travel Setting, 13

Trench Composting, 29

Troubleshooting,

- Engine, 67-69
- Tiller, 65-67

Turning Around, 21

Unloading/Loading, 22

Untangling Tines, 28

Uphill Tilling, 28

Vertical Tilling, 28

Viscosity

- Engine Oil, 51
- Gear Oil, 40, 70

Weight,

- Engine, 70-71
- Tiller, 70

Wheel Speed Lever,

- Function, 11
- Operation, 11
- Troubleshooting, 65

Wheel/Tine Speeds, 22-24, 70

Wheel Weights, 74

Wheels (see "Tires")

Wheels/Tines/PTO Drive Lever,

- Function, 9
- Forward Operation, 9
- Neutral, 9-10, 45
- Reverse Operation, 10, 20
- Troubleshooting, 65

Wide Rows, 31

Width, Tiller, 70

Wrench, PTO, 33

X Y Z



FULL NO-TIME-LIMIT WARRANTY

Your TROY-BILT® Roto Tiller - Power Composter is warranted by Garden Way Incorporated to be free from defects in materials and workmanship. This warranty will remain in effect for the life of the machine and will be transferred automatically to any and all subsequent owners.

We or your authorized dealer will repair or replace, at no cost to you, any part we find to be defective with the exception of the engine, which is warranted separately by the engine manufacturer. Garden Way Incorporated does, however, extend the length of the engine manufacturer's warranty, providing you with coverage for a total of three(3) years. (Call or write to us for a FREE copy of the engine warranty.)

This FULL NO-TIME-LIMIT WARRANTY also applies to all non-powered attachments. Powered attachments are warranted separately by their manufacturers.

If we determine them defective, even parts that wear in normal use, such as belts, bearings, blades, tires, and tines are covered under this warranty and will be replaced or repaired without charge. Failures or malfunctions caused by normal wear and tear, use of unauthorized accessories or attachments, misuse, or accident are not covered.

FULL ONE-YEAR COMMERCIAL USE WARRANTY: If used for commercial, institutional, industrial, rental or demonstrator purposes, the warranty on this product is limited in duration to one (1) year from date of purchase. The engine warranty for commercial use is a LIMITED WARRANTY also in effect for one (1) year from date of purchase. Proof of purchase is required to obtain commercial warranty service.

How to Get Service:

To obtain warranty service, contact Garden Way Incorporated at 102nd Street & 9th Avenue, Troy, NY 12180, or call us TOLL FREE at 1-800-833-6990, or consult your Yellow Pages for the name of the authorized TROY-BILT product dealer nearest you.

Your Rights Under State Law:

This warranty gives you specific legal rights, and you may also have other rights which vary from state to state.

Plus...You can try a TROY-BILT® Tiller for 30 days and then decide!

If for any reason you are not satisfied with your TROY-BILT® Tiller within 30 days from the time you receive it, notify us and return it.

We will refund the original price you paid for the product, plus we will pay shipping both ways!

19005540 (6/93)

Half-Price Factory Rebuilding Agreement

At any time, no matter how new or old your TROY-BILT® Roto Tiller-Power Composter may be, we will rebuild and repaint it, replacing every worn part (such as bearings, gears, seals, tines, belts, and including a new engine) for one-half the current retail price at the time of repair of that model or its equivalent

(if that exact model has been changed); owner to pay shipping and container costs to and from the factory. If any other than wearing parts need replacement, an estimate will be submitted to owner for approval. This offer, of course, is subject to fire, war, strikes, and other contingencies beyond our control.

